

PICOWORLD '16

IDEAS FOR EXCELLENCE

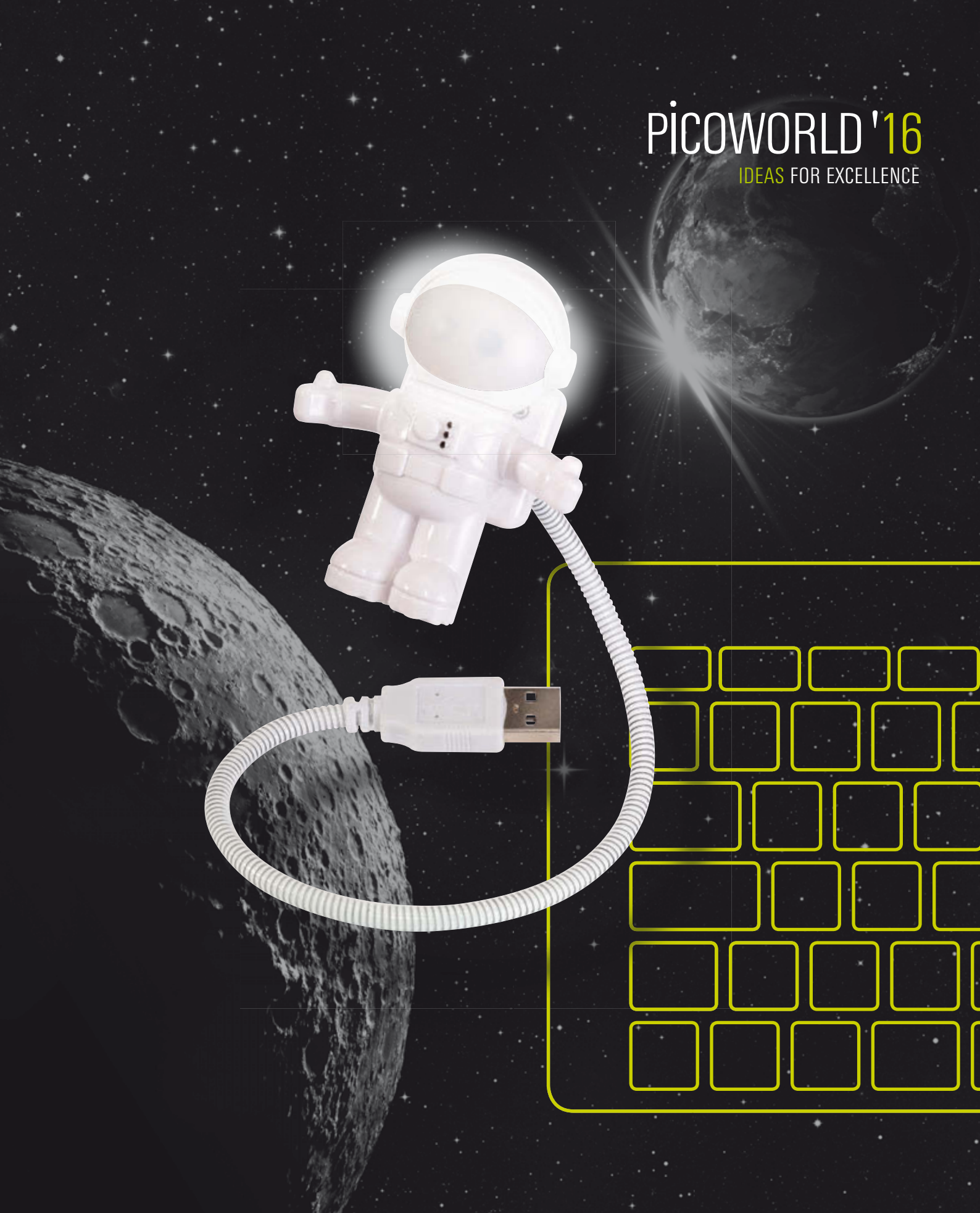

WELCOME

... to the PiCOWORLD 2016.

For those of us at PiCOWORLD, a promotional gift is more than a useful object which can be branded with a logo or slogan. It has to be unique!

An advertising item is the perfect medium to get sympathy points by a small gesture of giving. With our PiCOWORLD products you can either strengthen your customer relations or acquire new customers. A personal present expresses appreciation and solidarity, which is sometimes difficult to express in words.

For that reason, we are never satisfied with simple everyday objects in our search for new ideas. The result: carefully selected products that are characterized by individuality. High-quality innovations at good prices!

In order to do justice to the high demands we place on PiCOWORLD products, we have no limits on creativity – ours or yours! We make custom-made designs available to you at any time. Just tell us what your desired item should look like and we will take care of it.

First-class service is just as important to us as first-class promotional gifts. Just take a look at our picoservice tips regarding your order.

Dive in to our PiCOWORLD 2016 and let us surprise you.

„Enjoy!“

Your PiCOWORLD Team

PiCOWORLD '16



 **picopen**
Pens



 **picooffice**
Office accessories,
computer equipment
and powerbanks



 **picotime**
Clocks and
weather stations



 **picosound**
Radios, speakers
and headphones

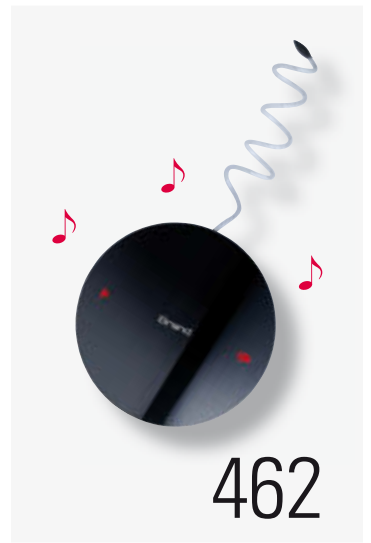

 **picolux**
Lamps
and torches



 **picoflame**
Lighters



 **picoactive**
Outdoor and tools



 **picotravel**
Travel accessories

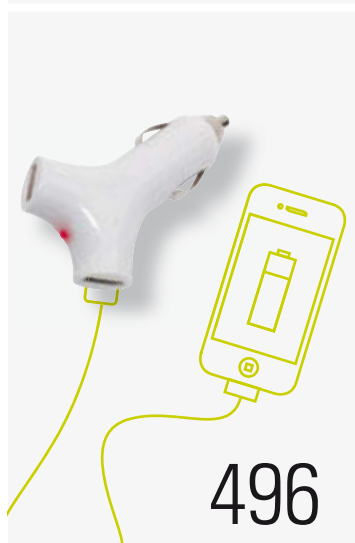

 **picostyle**
Key rings

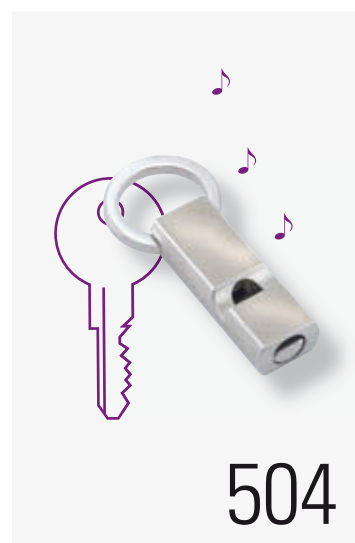

 **picohome**
Household and wine accessories



 **picogame**
Games

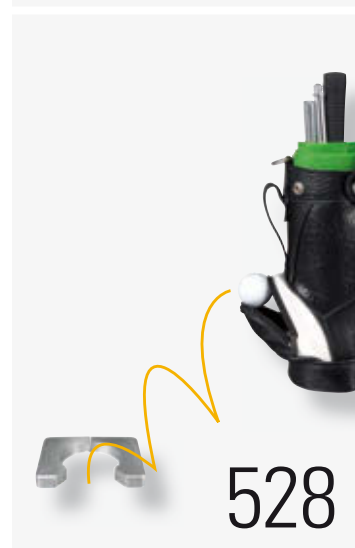

IDEAS FOR EXCELLENCE

Write away For all indescribable moments!

In the age of e-mails and WhatsApp a hand written letter is a bit out of fashion. Nevertheless, nothing is more enjoyable than closing a successful contract with own handwritten signature. Whether it is a ballpoint pen, a fountain pen, or a rollerball pen - it can tell you a lot about its owner. In a critical moment, you should therefore choose a writing instrument that you can rely on.

We pay great attention to create sparkling personality for our picopens, so you and your customers could stand out while leaving a mark. Let yourself be charmed by our complimentary pens!





Clip in PiCOWORLD design



58-8113001 white/silver
58-8113002 black/silver

highlight

TOUCH DOWN Stainless steel pen TOUCH DOWN: with high-capacity refill and twist mechanism, touchscreen point at the end of the shaft, in piano lacquer look with silver decorative elements, clip in PiCOWORLD design, black ink, packed in a gift box.

Packing: 200 pcs. /50 pcs. | Size: 13,75 x 1,4 cm | Branding:  30 x 7 mm K1+H2+V2 |  15 x 4 mm L1+H2



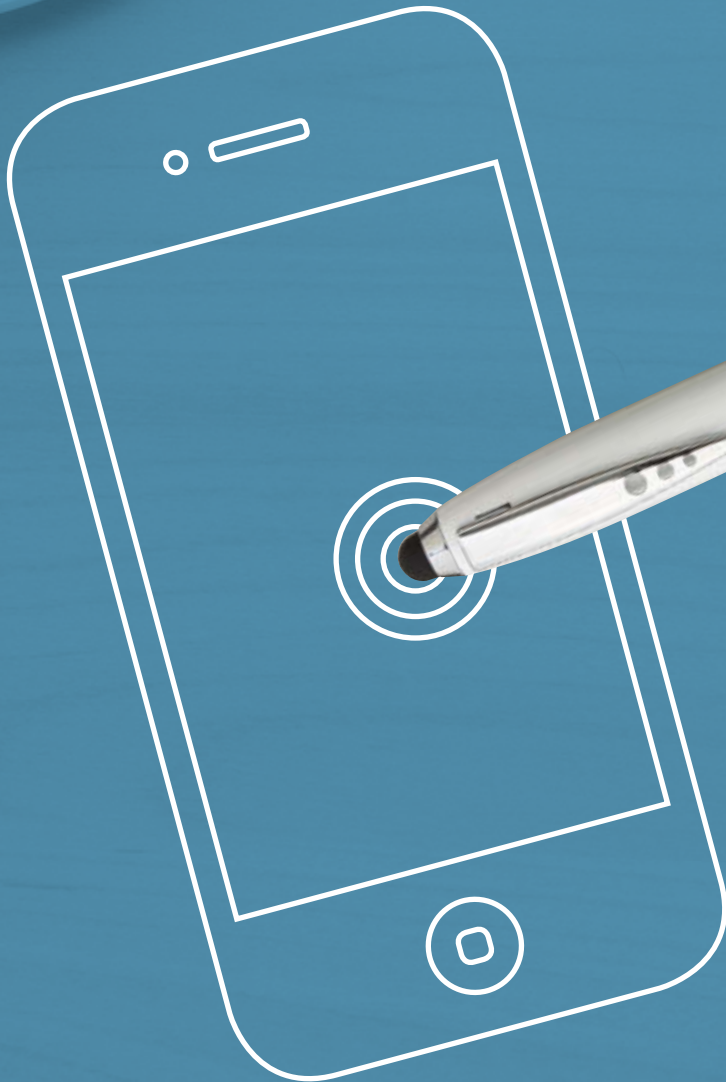

picopen

A nature-boy conquers the digital age.



With PDA touch-screen tip





With touchscreen point



without decoration

FINESSE 58-1100517 Metal ballpoint pen FINESSE: equipped with PDA tip, twist mechanism, blue ink, made of satin finish metal with polished chrome elements.

Packing: 200 pcs./50 pcs. | Size: 18,2x4x2,3/13x1,1 cm |
Branding:  40x5mm K2+H5+V1 |  40x5mm L2+H4



BAMBOO TOUCH 58-8110001 Ballpoint pen BAMBOO TOUCH: with spring mechanism, high-capacity refill, elegant bamboo shaft and touchscreen tip – suitable for tablet PCs etc. – blue ink.

Packing: 500 pcs./50 pcs. | Size: 14x1,2cm | Branding:  30x5mm K2+H4+V3

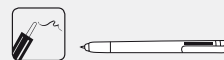



FLOATING PEN 58-1100377 Metal ballpoint pen FLOATING PEN with matching stand: twist ballpoint pen with blue ink, solid zinc stand - keeps pen floating through magnet.



Packing: 50 pcs. / 10 pcs. | Size: 12x2 xcm/Ø5,5x2,5cm |

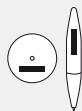

Branding:  20x8/10x4mm L2+H6



ARCHITECT 58-1100407 Writing set ARCHITECT: consists of 10 cm long special ruler (triangle shaped, 1:125m/1:100m/1:75m/1:50m/1:20m) and twist action ballpoint pen (blue ink), with non-slip grip and integrated spirit level, comes in zip box with metal surface.

Packing: 100 pcs. / 10 pcs. | Size: 17x5,5x2,9/13,5x1,1cm |

Branding:  30 x 2mm K2+H5+V2 |  50 x 20 mm K2+H2+V1 |

 150 x 40 mm DP2+H2 |  30x2mm L2+H5 |  50x20mm L2+H2



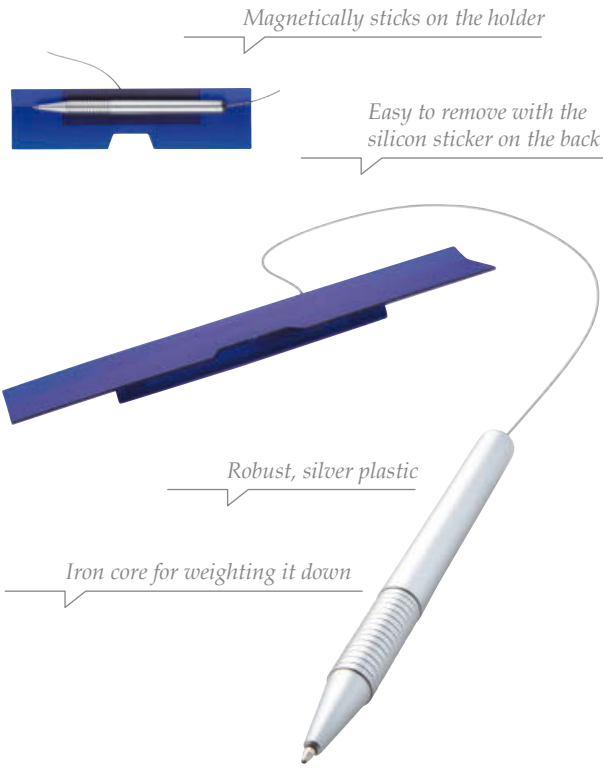

CATENA will never let your customers down!

CATENA 58-1102397 Plastic ballpoint pen CATENA: with an iron core to weigh it down and wall holder with silicone adhesive tape – pen adheres thanks to magnet in holder, blue ink.

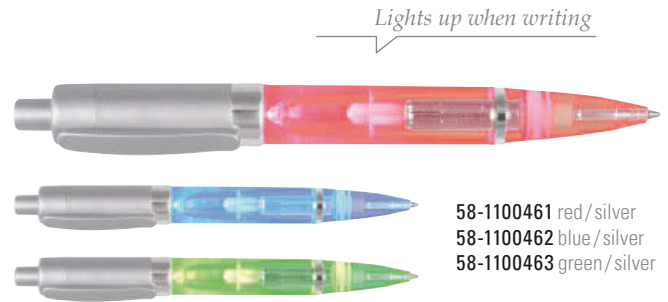
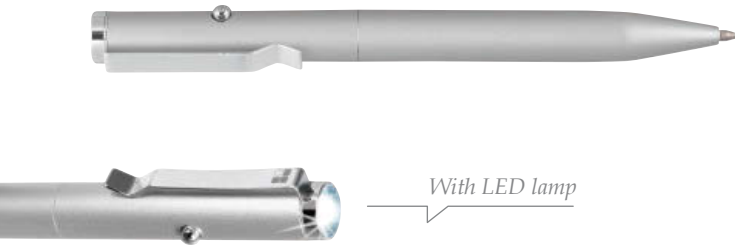
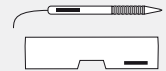

Packing: 200 pcs. / 50 pcs. | Size: 16,5x4,2x2 / 13x1,3 cm |

Branding:  20x5 mm K1+H2



LOOK 58-1101607 Metal ballpoint pen LOOK: with white LED lamp at the end of the shaft, twist mechanism, blue ink, delivered in case.

Packing: 200 pcs. / 50 pcs. | Size: 16 x 3 x 3 / 13,1 x 1,1 cm |

Branding:  35 x 5 mm K2+H4+V1 |  35 x 5 mm L2+H4



LUXOGRAPH LIGHT Ballpoint pen LUXOGRAPH LIGHT: with small LED light - activated through spring mechanism, pen lights up in different colours, blue ink, made of plastic.

Packing: 500 pcs. / 10 pcs. | Size: 14xØ1,8 cm | Branding:  25x6 mm K1+H1

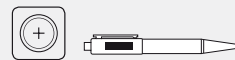

Tricky designer pen for spectacular writing performance.

UPPSALA 58-1101717 Ballpoint pen UPPSALA: unfolds to 16,7 cm when the button is pressed, measures 9,7 cm when folded and fits in every coat or trouser pocket, blue ink, made of plastic.

Packing: 400 pcs./200 pcs. | Size: 9,7x1,7x2,2cm | Branding: ☹ 20x10mm K1+H3



Unfolds at the push of a button

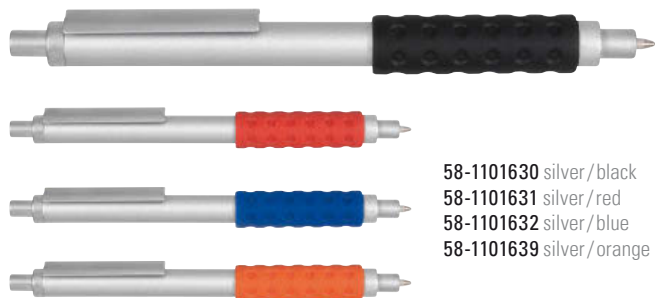

58-1101630 silver/black
58-1101631 silver/red
58-1101632 silver/blue
58-1101639 silver/orange



GRIP Metal ballpoint pen GRIP: with spring mechanism, ergonomic and rubberized grip in a wave design, blue ink.

Packing: 500 pcs./50 pcs. | Size: 14,2x1,3cm | Branding: ☹ 40x5mm K2+H4+V1 | ☹ 40x5mm L2+H4



MAX 58-1100471 Ballpoint pen MAX in compact design: with spring mechanism, decorative rubber grip, blue ink, made of plastic.

Packing: 500 pcs./10 pcs. | Size: 13,2xØ2,5cm | Branding: ☹ 20x7mm K1+H1



1



2



3



4



5



6



Decorated with CRYSTALLIZED™-
Swarovski Element



1 ROCK 58-1101590 Metal ballpoint pen ROCK: with twist mechanism, decorated with precious CRYSTALLIZED™-Swarovski Elements on the clip, blue ink, delivered in case.

Packing: 50 pcs. / 10 pcs. | Size: 18,5x7,8x3,3 / 13x1,3 cm |

Branding: ☒ 35x5 mm K2+H4+V2 | ☒ 180x70 mm DP2+H2 | ☒ 35x5 mm L2+H4



Clip in PiCOWORLD design



2 CARBONIUM 58-1102050 Metal ballpoint pen CARBONIUM: with twist mechanism, real carbon finish, silver clip in PiCOWORLD design, blue ink, delivered in case.

Packing: 200 pcs. / 50 pcs. | Size: 16x3x3 / 13,7x1 cm |

Branding: ☒ 25x6 mm L2+H4



58-1102211 red / silver
58-1102212 blue / silver



3 CANCUN 58-1102291 Ballpoint pen CANCUN: with spring mechanism, diamond pattern engraving on shaft, black ink.

Packing: 500 pcs. / 50 pcs. | Size: 13,5xØ1 cm |

Branding: ☒ 20x60 mm LR2+H4 360° | ☒ 40x6 mm L1+H4



4 SOKRATES Metal ballpoint pen SOKRATES: with spring mechanism - can be fixed onto a lanyard thanks to a little hole on the push button - aluminium rings on the grip, blue ink.

Packing: 500 pcs. / 50 pcs. | Size: 14xØ0,9 cm |

Branding: ☒ 20x60 mm LR2+H2 360° | ☒ 40x5 mm L1+H2



Clip in PiCOWORLD design



Transparent centre part with
moveable Swarovski Elements



58-1103025 black
58-1103028 white

5 SUCCESS 58-1102320 Metal ballpoint pen SUCCESS: with twist mechanism, "success" written on shaft in 14 languages, clip in PiCOWORLD design, blue ink, delivered in case.

Packing: 200 pcs. / 50 pcs. | Size: 18,2x4x2,3 / 13,5x1,3 cm |

Branding: ☒ 25x10 mm K2+H4+V2 | ☒ 25x10 mm L2+H4

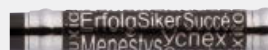

6 DIAMOND Metal ballpoint pen DIAMOND: with twist mechanism, transparent centre piece with movable CRYSTALLIZED™-Swarovski crystals, clip in PiCOWORLD design, blue ink, delivered in case.

Packing: 200 pcs. / 50 pcs. | Size: 14x1 cm | Branding: ☒ 20x5 mm L2+H4

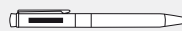

Our pens have that certain something that will impress your customers.





Clip in PiCOWORLD design



PRECISE 58-1102287 Metal roller pen PRECISE: rubberized grip at mid-point, clip on cap in PiCOWORLD design, black ink, delivered in case.

Packing: 200 pcs./50 pcs. | Size: 18,2x4x2,3/14x1,4cm |

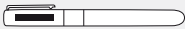

Branding:  25x10mm DP1+H4 |  25x10mm L2+H4 |

 40x40mm LR2+H4 360°



ALL IN ONE 58-1102370 Multi-functional pen ALL IN ONE: 3 tools in one pen - ballpoint pen (blue ink), pencil and PDA stylus, with spring mechanism, made of aluminium.

Packing: 200 pcs./50 pcs. | Size: 18,2x4x2,3/14x1 cm |

Branding:  25x25mm LR1+H4 360° |  25x5mm L2+H4



With precious CRYSTALIZED™-
Swarovski Elements

Clip in exclusive PiCOWORLD design



MOSCOW 58-1101560 Metal ballpoint pen MOSCOW in black piano lacquer look: with twist mechanism, clip in PiCOWORLD design, 24 CHRYSTALLIZED™-Swarovski Elements on the shaft, blue ink, delivered in case.

Packing: 50 pcs. / 10 pcs. | Size: 20,5x8,3x3,3 / 13,5x1,9cm |

Branding: ☒ 35x5mm K2+H4+V2 | ☒ 180x70mm DP2+H2 | ☒ 35x5mm L2+H4



Clip in exclusive PiCOWORLD design



With precious CRYSTALIZED™-
Swarovski Elements



RIGA 58-1101570 Metal roller pen RIGA in black piano lacquer look: cap with clip in PiCOWORLD design, 24 CHRYSTALLIZED™-Swarovski Elements on the shaft, black ink, delivered in case.

Packing: 50 pcs. / 10 pcs. | Size: 18,5x7,8x3,3 / 13x1,3cm |

Branding: ☒ 35x5mm K2+H4+V2 | ☒ 180x70mm DP2+H2 | ☒ 35x5mm L2+H4



Clip in exclusive PiCOWORLD design



With precious CRYSTALIZED™-
Swarovski Elements



ST. PETERSBURG 58-1101580 Metal fountain pen ST. PETERSBURG in black piano lacquer look: with Iridium Point nib, cap with clip in PiCOWORLD design, 24 CHRYSTALLIZED™-Swarovski Elements on the shaft, incl. 1 ink-refill, delivered in case.



Packing: 50 pcs. / 10 pcs. | Size: 19,2x8,3x3,3 / 13,6x1,3cm |

Branding: ☒ 35x5mm K2+H4+V2 | ☒ 180x70mm DP2+H2 | ☒ 35x5mm L2+H4



CHAMPAGNE 58-1100687 Metal ballpoint pen CHAMPAGNE: with twist mechanism, delicate mosaic design, blue ink, supplied in elegant PU-leather presentation box with metal plate for your advertisement.



Packing: 100 pcs. / 10 pcs. | Size: 18,2x5,7x3,5 / 14x1,5 cm |

Branding:  30x5 / 25x5 mm K2+H4+V2 |  30x5 / 25x5 mm L2+H4



CALLIGRAPH 58-1100520 Metal ballpoint pen CALLIGRAPH: with twist mechanism, glossy chrome elements, blue ink, supplied in gift box with embossed leatherette.

Packing: 200 pcs. / 25 pcs. | Size: 15,8xØ2,7 / 14x1 cm |



Branding:  25x6 mm K2+H5+V2 |  25x6 mm L2+H4



Delicate embossing

KIEV 58-1102190 Metal ballpoint pen KIEV: with twist mechanism, gold trim, with precious CRYSTALLIZED™-Swarovski Element on the clip, blue ink, delivered in gift box.

Packing: 50 pcs. / 10 pcs. | Size: 18,5x7,8x3,3 / 13x1,3 cm |

Branding:  35x5 mm K2+H4+V2 |  180x70 mm DP2+H2 |  35x5 mm L2+H4



A striking contrast: accents in shiny gold tones



With precious CRYSTALLIZED™-Swarovski Elements



PiCO pens radiate natural charme.

BORG 58-1102259 Wooden ballpoint pen BORG: with twist mechanism, silver decorative elements, blue ink, supplied in wooden gift box.



Packing: 100 pcs. / 25 pcs. | Size: 16 x 3 x 3 / 14 x 1 cm |

Branding:  30 x 1 mm K2+H5 |  30 x 5 mm K2+H5



FLEX 58-1101840 Metal ballpoint pen FLEX: with twist mechanism, piano lacquer look with chrome elements, ergonomic grip for best handiness, with picopen logo, blue ink, delivered in case.

Packing: 50 pcs. / 10 pcs. | Size: 18,5 x 7,8 x 3,3 / 13,6 x 1,3 cm |

Branding:  35 x 5 mm K2+H4+V2 |  35 x 5 mm L2+H4



58-1100660 black/silver

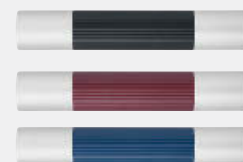

58-1100661 red/silver

58-1100662 blue/silver



COLUMN Metal ballpoint pen COLUMN: with twist mechanism, coloured and shiny chrome-plated barrel, blue ink, supplied in matching gift box.

Packing: 200 pcs. / 10 pcs. | Size: 15,7 x Ø 2,7 / 13,8 x 1,2 cm |

Branding:  30 x 5 mm K2+H6+V2 |  30 x 5 mm L2+H6





58-1100630 black/silver
58-1100631 red/silver



Elegant cases are the icing on the cake.

ADORNO Writing set ADORNO: consists of metal roller ball (black ink) with cap and black grip and metal twist action ballpoint pen (blue ink), delivered in matching striped box.

Packing: 100 pcs./10 pcs. | Size: 17x6x2,3/13,8x1,9 cm |
Branding: ☞ 35x5 mm K2+H5 | ☞ 150x50 mm DP2+H2 | ☞ 35x5 mm L2+H5

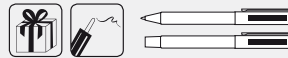

58-1100620 black/silver
58-1100621 red/silver
58-1100622 blue/silver



ADORNO Metal ballpoint pen ADORNO: with twist mechanism, body with striped design, blue ink, delivered in matching striped box.

Packing: 100 pcs./10 pcs. | Size: 17x6x2,3/13,8x1,9 cm |
Branding: ☞ 35x5 mm K2+H4 | ☞ 170x60 mm DP2+H2 | ☞ 35x5 mm L2+H4





58-1100490 black/silver
58-1100497 silver



STERLING Writing set STERLING: consists of metal roller ball with cap (black ink) and metal twist action ballpoint pen with high-capacity refill (blue ink), delivered in elegant gift box with aluminium plate.

Packing: 50 pcs. / 10 pcs. | Size: 17,3x6,7x3,5/14x1,2 cm |

Branding: ☒ 30x6 mm K2+H5+V2 | ☒ 40x40 mm K2+H2+V2 |

☒ 40x40 mm DP2+H2 | ☒ 30x6 mm L2+H5 | ☒ 40x40 mm L2+H2



COMTESSE 58-1100464 Writing set COMTESSE: consists of metal roller ball with cap (black ink) and metal twist action ballpoint pen (blue ink), with polished chrome elements, comes in gift box.

Packing: 100 pcs. / 10 pcs. | Size: 17x4,5x2/13,7x1,3 cm |

Branding: ☒ 20x5 mm K2+H5+V1 | ☒ 150x40 mm DP2+H2 | ☒ 20x5 mm L2+H5



Clip in PiCOWORLD design



ALBUS 58-1102335 Writing set ALBUS: consists of roller pen with cap and black grip (black ink) and twist action ballpoint pen (blue ink), with chrome applications, delivered in white gift box with aluminium plate.

Packing: 50 pcs. / 10 pcs. | Size: 17,6x6,8x3,8/13,8x1,2 cm |

Branding: ☒ 40x40/35x5 mm K2+H2+V2 | ☒ 35x5 mm K2+H5+V2 |

☒ 40x40 mm DP2+H2 | ☒ 35x5 mm L2+H5







Clip in PiCOWORLD design



A true classic! Low cost, easy to print on and with high practical value.

WOOD AND METAL 58-1103037 Writing set WOOD AND METAL: consists of metal roller pen with cap (black ink) and metal twist action ballpoint pen (blue ink), brushed shafts with glossy decorative elements, clip in PiCOWORLD design, supplied in a bamboo gift box.

Packing: 50 pcs. / 25 pcs. | Size: 14 x 1,3 / 17,5 x 5,5 x 2,6 cm |

Branding:  175 x 55 mm DP2+H2 |  20 x 5 mm L2+H4



58-1100420 black/silver

58-1100422 blue/silver





With rotary mechanism: turn into one direction for adjusting the refill and into opposite direction for fixation



EDITOR Writing set EDITOR: consists of pencil and twist action ballpoint pen (blue ink), satin finished metal and finely ribbed coloured plastic body, supplied in box.

Packing: 100 pcs. / 10 pcs. | Size: 16,3 x 6,2 x 2,6 / 13,3 x 1,4 cm |

Branding:  30 x 5 mm K2+H5+V2 |  160 x 60 mm DP2+H2 |  30 x 5 mm L2+H5



PRECIOUS 58-1102450 Writing set PRECIOUS: consists of ballpoint pen (blue ink) and pencil with twist mechanism, both writing utensils have an exclusive wooden design with chrome-plated decorative elements, triangular shaped shaft, delivered in gift box with maplewood applications.

Packing: 50 pcs. / 25 pcs. | Size: 20 x 7,5 x 4,7 / 14,3 x 1,2 cm |

Branding:  25 x 10 / 40 x 30 mm K2+H4



For peak performance –
great products with
power of endurance!

OLYMPIC 58-1102317 Writing set OLYMPIC: consists of metal roller pen with cap (black ink) and metal twist action ballpoint pen (blue ink), with delicate helix engraving on shaft, delivered in a stylish box with aluminium plate for your advertising.

Packing: 50 pcs. / 10 pcs. | Size: 17,4x6,7x3,5 / 14x1,7 cm |

Branding: ☒ 40x40 mm K2+H2+V2 | ☒ 35x5 mm K2+H5+V2 |

☒ 40x40 mm DP2+H2 | ☒ 35x5 mm L2+H5 | ☒ 40x40 mm L2+H2

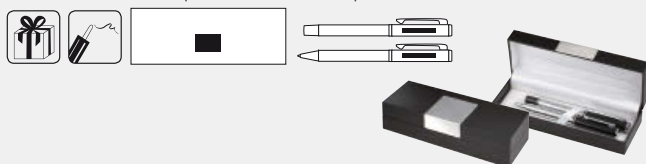

BROADWAY 58-1100410 Writing set BROADWAY: consists of metal roller ball with cap (black ink) and metal twist action ballpoint pen (blue ink), with interwoven black and shiny chrome finish on the barrel, supplied in box.

Packing: 100 pcs. / 10 pcs. | Size: 16,2x6x2,8 / 14,1x1,1 cm |

Branding: ☒ 30x3 mm K2+H5+V2 | ☒ 160x60 mm DP2+H2 | ☒ 30x3 mm L2+H5

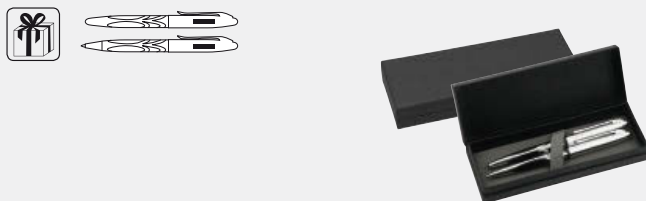

SKRIPTUS 58-1100500 Writing set SKRIPTUS: consists of metal roller ball with cap (black ink) and metal twist action ballpoint pen (blue ink), with silver decor elements, comes in gift box.

Packing: 100 pcs. / 10 pcs. | Size: 16x5,5x3,5 / 13x1,3 cm |

Branding: ☒ 30x15 mm K2+H2+V2 | ☒ 35x5 mm K2+H5+V2 |



☒ 30x15 mm L2+H2 | ☒ 35x5 mm L2+H5









Two elegant helpers, for a great writing experience.

BLACK ELEGANCE 58-8114001 Writing set BLACK ELEGANCE: consists of ballpoint pen with twist mechanism and metal refill (black ink), and fountain pen with ink cartridge (blue ink) in gun-metal look with rubber-coated grip, both writing instruments with PiCOWORLD clip, black gift box with drawer and decorative edge made of aluminium.

Packing: 50 sets / 25 sets | Size: 19,8x7,9x3,7 cm | Branding:  40x6 mm K2+H5 |  40x6 mm L1+H5 |  90x3 mm L1+H4



BOHEMIAN 58-1100530 Writing set BOHEMIAN: consists of metal roller ball with cap (black ink) and metal twist action ballpoint pen (blue ink), with silver decor elements, supplied in gift box with metal inset.



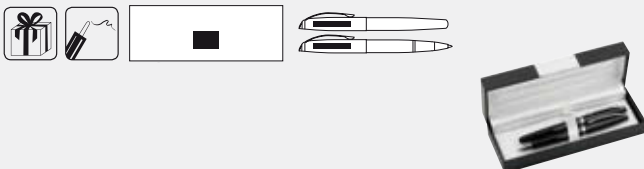

Packing: 50 pcs. / 25 pcs. | Size: 18,0x6,5x4/13x1,3 cm | Branding:  25x5 mm K2+H5+V2 |  40x40 mm K2+H2+V2 |  40x40 mm DP2+H2 |  25x5 mm L2+H5 |  40x40 mm L2+H2



Clip in PiCOWORLD design



CARBON 58-1100580 Writing set CARBON: consists of metal roller ball with cap (black ink) and metal twist action ballpoint pen (blue ink), real carbon finish, clip with PiCOWORLD design, supplied in elegant gift box with metal inset.

Packing: 50 pcs. / 10 pcs. | Size: 17,5x7x4/13,8x1,3 cm | Branding:  35x5 mm K2+H5+V2 |  40x40 mm K2+H5+V2 |  40x40 mm DP2+H2 |  35x5 mm L2+H5 |  40x40 mm L2+H5

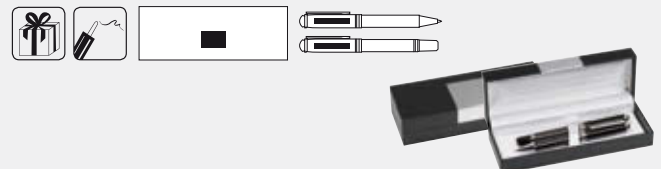

Clip in PiCOWORLD design



INTERCONTINENTAL 58-1102300 Writing set INTERCONTINENTAL: consists of metal roller pen with cap (black ink) and metal twist action ballpoint pen (blue ink), with brilliant chrome world map design on shaft, clip in PiCOWORLD design, delivered in a stylish box with aluminium plate.

Packing: 50 pcs. / 10 pcs. | Size: 18x6,5x4 / 14x1,5cm |

Branding: ☒ 35x5mm K2+H5+V2 | ☒ 40x40mm K2+H2+V2 |

☒ 40x40mm DP2+H2 | ☒ 35x5mm L2+H5 | ☒ 40x40mm L2+H5



TRIO 58-1102410 Writing set TRIO, 3 pcs: consists of fountain pen with iridium nib, incl. 1 ink cartridge, roller pen (black ink) and twist action ballpoint pen (blue ink), pens made of solid metal with piano lacquer finish and brilliant chrome elements, delivered in gift box with aluminium plate for your advertisement.

Packing: 50 pcs. / 10 pcs. | Size: 13,8x1,1 / 17,8x6,6x2,5cm |

Branding: ☒ 35x5mm K2+H5+V2 | ☒ 40x40mm K2+H5+V2 |

☒ 40x40mm DP2+H2 | ☒ 35x5mm L2+H5 | ☒ 40x40mm L2+H5

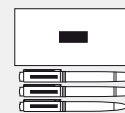

Front Office Joint venture of form and function!

Even if you don't want to believe it, but a person spends most of their time at work. Which is ideally supposed to be fun, therefore the equipment has to be just right. Starting from the computer all the way to the small office helpers. Working with a stylish letter opener or a fancy calculator, it makes easier to get the job done in no time!

Our picooffice ideas guarantee fun for everyone. They are more than industrious everyday helpers; many of them are celebrated for their entertainment value.



highlight

SHERLOCK 58-8116002 Magnifying glass
SHERLOCK with 3-fold magnification, 2 white LED lights, on/off switch on the side, with fold-out stand, batteries: 2 x AA (excl.).
Packing: 100 pcs. / 25 pcs. | Size: 16,3x7,6x2 cm |
Branding: ☞ 22x10 mm K2+H4+V2 | ☞ 20x10 mm DP1+H4



picooffice



picooffice



WINGMAN 58-1101515 Rotating calculator WINGMAN in handy size: display is automatically extended and retracted by pressing a button, with rubberized keypad, 8-digit.

Packing: 100 pcs. / 50 pcs. | Size: 10,6x3,6x1,8 cm |

Branding:  Ø20 mm K2+H2+V1



NOIR 58-1101870 Calculator NOIR: display is almost invisible when turned off, 8-digit, delivered in velvet bag.

Packing: 100 pcs. / 50 pcs. | Size: 11,2x6,6x0,9 cm |

Branding:  40x7 mm K2+H3+V1

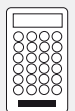

Practical and beautiful don't go together?
Our PicoOffice treasures prove they do!



TRANS-SCRIPT 58-1102380 Calculator TRANS-SCRIPT, 10-digit: with integrated translator for 6 languages (German, English, French, Spanish, Dutch, Italian), 120 sentences and 5000 words, with ruler (30 cm) and date and time display.

Packing: 60 pcs. /30 pcs. | Size: 31 x 5,6 x 0,9 cm | Branding: ☞ 40x30mm K2+H3

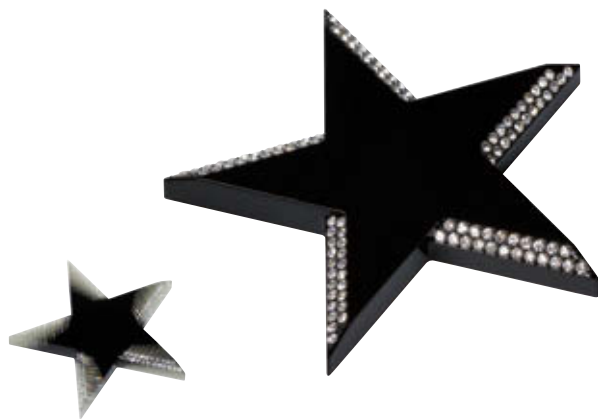

TRONDHEIM 58-1102010 Paper weight TRONDHEIM, rotating: made of heavy black metal to weigh down letters or documents, star ends adorned with sparkling rhinestones.

Packing: 24 pcs. | Size: 12,2x12,2x1,1 cm | Branding: ☞ 30x30mm K2+H2+V2



BERGEN 58-1101967 Letter opener BERGEN: with rhinestones on the handle, made of heavyweight metal.

Packing: 50 pcs. | Size: 19,6x2,1 x 0,8 cm | Branding: ☞ 60x10mm L2+H4



Made of highly polished aluminium



58-1102361 red
58-1102362 blue
58-1102364 gold



MEMO Mini notepad MEMO: handy breast pocket size, with twist action ballpoint pen (black ink) attached to the side, made of shiny aluminium.

Packing: 100 pcs./20 pcs. | Size: 11 x 7 x 1 cm | Branding: ☒ 40 x 30 mm K2+H3+V1 | ☒ 100 x 60 mm DP2+H2 | ☒ 40 x 30 mm L2+H3

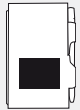

58-0401530 black
58-0401535 white



DORADO 58-1101210 Pen holder DORADO: convenient mug shape in slightly slanted design, with chromed rim, made of metal.

Packing: 40 pcs./20 pcs. | Size: 9,4 x Ø 6 cm | Branding: ☒ 50 x 15 mm K2+H6+V2 | ☒ 130 x 50 mm LR3+H6 360° | ☒ 50 x 15 mm L2+H6

KALMAR Memo holder KALMAR: suitable for photos and notes, with practical snap clip, made of plastic.

Packing: 400 pcs./100 pcs. | Size: 6,5 x 4,3 x 3,9 cm | Branding: ☒ 25 x 25 mm K1+H1+V1



Business à la carte: Never lose track of business cards again.

MASTER FILE 58-8117000 Address register MASTER FILE: two drawers with address and number register, ideal for storing business cards, made of shiny black metal with piano lacquer finish.

Packing: 10 pcs. | Size: 11,8x13,3x16,4 cm | Branding: 🖨️ 20x30 mm L2+H6

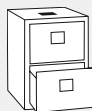

Case made of transparent acrylic



LILLEHAMMER 58-1102037 Business card case
LILLEHAMMER: with spring lock, made of silver-coloured metal and transparent acrylic.

Packing: 100 pcs. | Size: 10,4x6,8x1 cm | Branding: 🖨️ 50x25 mm K2+H2+V1 |
🖨️ 50x30 mm DP2+H2 | 🖨️ 50x30 mm L2+H2





1



2



3



4



5



6



With solenoid shutter on both sides

1 SAO PAULO 58-1101260 Business card holder SAO PAULO made of elegant leatherette: with magnetic clasps on both sides.

Packing: 200 pcs. / 50 pcs. | Size: 10x6x1,5 cm | Branding: ☒ 50x10 mm DP1+H2 | ☒ 50x10 mm L2+H2



2 RIO 58-1101690 Business card case RIO: aluminium inside, high quality leatherette outside, with secure metal magnetic clasp where your logo can be advertised.

Packing: 100 pcs. / 20 pcs. | Size: 10x6,5x1,5 cm | Branding: ☒ 25x10 mm L2+H2



3 IDENTITY 58-1101027 Business card case IDENTITY: with hinged breech block, made of matt aluminium.

Packing: 500 pcs. / 50 pcs. | Size: 9,4x6,2x0,8 cm | Branding: ☒ 50x25 mm K2+H2+V1 | ☒ 90x50 mm DP2+H2 | ☒ 50x50 mm L1+H2



Made of real leather with an inlaid slipcase

4 PROFESSION 58-1101000 Business card case PROFESSION: made of precious leather.

Packing: 200 pcs. / 50 pcs. | Size: 10,2x6,9x1,9 cm | Branding: ☒ 45x20 mm K2+H2



58-1101924 copper
58-1101928 silver

5 FREDRIKSHAVEN Business card holder FREDRIKSHAVEN: swings open, made of metal and plastic.

Packing: 50 pcs. | Size: 10,1x6,4x2 cm | Branding: ☒ 70x20 mm K2+H3 | ☒ 70x50 mm DP2+H2



6 PIET 58-1102230 Business card case PIET: interior has a velvet lining to protect business cards, outside polished base and top cover in textured leather look refined with white stitching, with secure magnetic clasp.

Packing: 100 pcs. / 20 pcs. | Size: 9,6x6,4x1 cm | Branding: ☒ 70x7 mm L1+H2





MILANO-TRAVEL 58-1101350 Briefcase MILANO-TRAVEL in leatherette look: capacity for 8 credit cards, papers and A5 notepad (excl.), 1 transparent pocket, pen holder, with silver magnetic clasp, incl. non-woven bag.
 Packing: 20 pcs. | Size: 23,3 x 14 x 1,5 cm | Branding:  30 x 8 mm L2+H4



HALMSTAD 58-1102130 Business folder HALMSTAD: with 4 different-sized compartments for ticket, passport, visa and boarding card, pen holder, all-around zip, made of sturdy twill.
 Packing: 60 pcs. | Size: 25,5 x 14 x 2 cm | Branding:  50 x 20 mm T2+H2



All-rounder for everyday business



MILANO-PORTFOLIO II 58-1101340 Organizer
MILANO-PORTFOLIO II in leatherette look: provides space for 6 business or credit cards, 2 large pockets for papers, pen holder, incl. notepad (A5), incl. non-woven bag.

Packing: 20 pcs. | Size: 23,7 x 15,2 x 1,5 cm | Branding: 30 x 8 mm L2+H4



CLASSICO-PORTFOLIO II 58-1101380 Organizer
CLASSICO-PORTFOLIO II in real leather look: with various separate pockets, pen holder, incl. A5 notepad, with magnetic metal clasp, incl. non-woven bag.

Packing: 20 pcs. | Size: 24 x 15,4 x 1,8 cm | Branding: 50 x 20 mm K2+H4 | 30 x 8 mm L2+H4

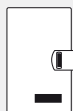

Great helpers! Everything you need is inside our portfolios and briefcases.



MILANO-PORTFOLIO 58-1101330 Organizer
 MILANO-PORTFOLIO in leatherette look: with calculator, 2 business card pockets, 2 pockets for papers, pen holder, incl. notepad (A4), with safe all-around zip, incl. non-woven bag.
 Packing: 20 pcs. | Size: 32 x 24,3 x 2,5 cm | Branding:  30 x 8 mm L2+H4



CLASSICO-PORTFOLIO 58-1101370 Organizer
 CLASSICO-PORTFOLIO in real leather look: with ultra slim calculator, 2 business or credit card pockets, 1 pocket for papers, 1 pocket for a notepad, pen holder, incl. A4 notepad.
 Packing: 10 pcs. | Size: 32 x 25 x 2 cm | Branding:  30 x 8 mm L2+H4



EMINENCE 58-8081004 Portfolio EMINENCE in DIN A4 format:
 with all-around zip, various slip-in pockets for business cards and documents, additional zip pocket, incl. notepad, pen holder, made of PVC and felt.
 Packing: 20 pcs. / 10 pcs. | Size: 34 x 25 x 3,5 cm | Branding:  50 x 50 mm T2+H2

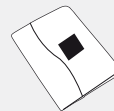



without decoration

SILVER-LINE PORTFOLIO 58-1101490 Organizer
 SILVER-LINE PORTFOLIO in real leather look: with calculator, 3 pen holders, 7
 business card pockets, incl. A4 notepad, secure magnetic closure, silver-coloured
 printing and engraving area for your advertisement, made of polyurethane, incl.
 non-woven bag.

Packing: 10 pcs. | Size: 32,5x29,5x2,5 cm | Branding: 📏 10x20 mm L2+H4



EMINENCE 58-8081003 Document portfolio EMINENCE in DIN
 A4 format: with all-around zip, ring binder, various slip-on pockets for business
 cards and documents, additional zip pocket, incl. notepad, PVC carrying handle, felt
 surface.

Packing: 10 pcs. / 5 pcs. | Size: 35,5x25x5 cm | Branding: 📏 50x50 mm T2+H2



without decoration



Let us take
some weight off
your shoulders!

CLASSICO-BAG 58-1101410 Briefcase CLASSICO-BAG in real leather look: 2 reinforced pockets for A4 documents, adjustable, reinforced and padded shoulder strap, with metal security lock, made of polyurethane, incl. non-woven bag.

Packing: 10 pcs. | Size: 39x29,5x5,5 cm | Branding:  20x8 mm L2+H3

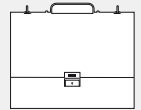

Padded comfortable carrying handle

Adjustable, soft padded shoulder strap

Reinforced document compartments

Incl. non-woven bag



3-digit security combination lock



SILVER-LINE BAG 58-1101500 Briefcase SILVER-LINE BAG in real leather look: 3 large compartments, including mobile phone and pen holder, 4 credit card pockets, 1 small zipped pocket, 1 laptop zip compartment and extra pocket, adjustable shoulder strap, reinforced handle, combination lock, silver-coloured printing and engraving area for your advertisement, made of polyurethane, incl. non-woven bag.

Packing: 5 pcs. | Size: 41,5x32x11 cm | Branding:  10x20 mm L2+H4



Grey eminence – feel confident with PiCOWORLD's briefcases.

EMINENCE 58-8081002 Document bag EMINENCE: organizing pocket for pens and smartphone, spacious main pocket with extension fold, metal locks, carrying handle, adjustable and removable shoulder strap, made of felt and PVC.

Packing: 10 pcs./5 pcs. | Size: 40x32x6cm | Branding:  50x50 mm T2+H2

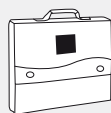

EMINENCE 58-8081001 Shoulder bag EMINENCE: organizer with carabiner to attach keys, 2 zip pockets, one Velcro pocket, various slip-in pockets, a spacious main zip compartment with zipped extension fold, cover with snap locks and hidden zip compartment, carrying handle, adjustable and removable shoulder strap, made of felt and PVC.

Packing: 15 pcs./5 pcs. | Size: 42x35x10 cm | Branding:  50x50 mm T2+H2



NEW AGE 58-8084000 Portfolio NEW AGE in leatherette look: with removable iPad cover (approx. 24 x 17,7 cm), space for 5 business cards and notepad, 1 transparent pocket, 1 large slip-in pocket, pen holder, with all-around zip.

Packing: 10 pcs. | Size: 29,3x23,3x3,5/24,5x21 x 1,7 cm |

Branding:  90x30 mm S2+H4



Removeable cover for iPad 2 (format approx. 24 x 17,7cm) with stand



MOBILITY 58-8105001 Protective cover MOBILITY – for iPad 2 or tablet PCs (approx. 24 x 17,7 cm): elastic strap, fold-out pocket for notes - can also be used as stand, inside covered with velvet velour, with hole for camera framed by metal insert, outside leather-look with decorative stitching and closing flap.

Packing: 50 pcs./ 25 pcs. | Size: 19,8 x 25 x 1,8 cm |

Built-in camera-hole rimmed with metal eyelet



Elastic strap for easy handling



With fold-out pocket for notes - also used as a stand



BACKPACK 58-1102460 Computer bag BACKPACK: 2 main zip pockets, one with padded laptop compartment, 2 zip front pockets, integrated organizer, padded back area, adjustable shoulder straps, strong handle, dirt-resisting base, made of robust nylon.

Packing: 10 pcs. | Size: approx. 43x32 x 14 cm | Branding:  50x30 mm T2+H2



Ideal protection for
our digital darlings.



12 compartments with
4 CD pockets each



PROTECT 58-1101420 Neoprene laptop bag PROTECT: with protective padding, all-around zip, Velcro inside to secure laptop and tablet PC, suitable for devices up to a size of ca. 24 x 34 cm, made of water-repellent neoprene, incl. non-woven bag.

Packing: 20 pcs. | Size: 39x30x1,3 cm | Branding:  80x80 mm T2+H2



SILVER-LINE CD-CASE 58-1101480 SILVER-LINE CD-CASE in real leather look: provides space for 48 CDs, with silver-coloured printing and engraving area for your advertisement, made of polyurethane, incl. non-woven bag.

Packing: 20 pcs. | Size: 18,2x32,5x2 cm | Branding:  10x20 mm L2+H4



UNIVERSAL 58-1103060 USB kit UNIVERSAL: incl. optical mini mouse with 2 buttons, scroll wheel and cable reel, card reader (Mini SD, SD, XD, MS), 4-port HUB, USB number pad, supplied in zip case with printing and engraving plate for your advertisement.

Packing: 24 pcs. | Size: 22,5x15,5x5 cm | Branding:  50x5 mm L2+H4



The PiCO mice will click with your customers.



PC TRACER 58-1102227 Optical USB computer mouse PC TRACKER in the shape of a racing car: 2 buttons and scroll wheel, USB cable (length approx. 145 cm), shining head- and backlights, resolution: 800 dpi, Plug + Play (no software needed).

Packing: 100 pcs. / 25 pcs. | Size: 10,2 x 5,2 x 3,5 cm |

Branding:  30 x 15 mm K2+H4+V1

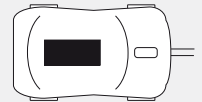

58-1102610 black
58-1102630 white



SINUO Optical mouse SINUO, wireless: with 2 buttons and scroll wheel, USB dongle attached to bottom side with magnet, resolution: 800/1.600 dpi, range: up to 10 m, Plug + Play (no software needed), batteries: 2 x AAA (excl.).

Packing: 100 pcs. / 20 pcs. | Size: 11,4 x 5,7 x 3,3 cm | Branding:  30 x 10 mm K2+H4





PLAY IT 58-0401555 Key ring PLAY IT: with digital photo frame, storage capacity: 1 MB (approx. 35 pictures), date and time display, alarm function, two games, incl. USB cable (length approx. 123 cm), made of solid plastic.

Packing: 50 pcs. / 25 pcs. | Size: 7,5x4,5x1,7 cm | Branding: ☒ 8x8 mm K1+H4



PRIVATE KEY 58-0300290 PC lock PRIVATE KEY: locks and unlocks the PC after exceeding a certain distance – suitable for PC and laptop users, includes CD with driver, small transmitter, USB flash drive with receiver, supplied in box with magnetic closure.

Packing: 60 pcs. | Size: 6,7 x 2,2 x 0,8 cm | Branding: ☒ 10x10 mm K2+H4+V2

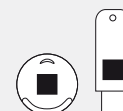

CARY 58-1103020 Card reader CARY: reads all standard memory cards: CF, SD, Mini SD, MS, Micro SC, mmC, XD - incl. USB cable (length approx. 40 cm), device supports USB 2.0, for Mac and Windows.

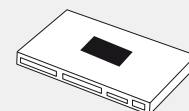

Packing: 100 pcs. | Size: 8,3x5,4x1,0 cm | Branding: ☒ 40x20 mm DP1+H2 | ☒ 40x20 mm L2+H4







TRAVEL GEAR 58-1100110 USB kit TRAVEL GEAR: 4-port HUB, mini optical mouse, swan neck fan and LED light, comes in case with metal plate for your advertisement.

Packing: 20 pcs. / 10 pcs. | Size: 16,5x16,5x5 cm |

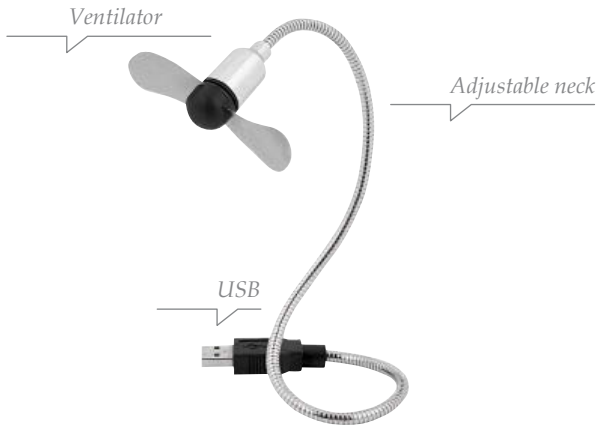
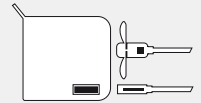
Branding:  25x25/15x5 mm K2+H4+V2 |  25x25/15x5 mm L2+H4



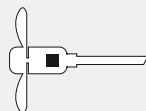

AERO FRESH 58-1100127 USB fan AERO FRESH: chrome-coated flexible neck, with USB adapter, no external power supply required.

Packing: 100 pcs. / 20 pcs. | Size: 38,3xØ 1,5cm | Branding:  15x5 mm K2+H4+V2 |  10x7 mm L2+H4



VIPERE 58-1100107 USB light VIPERE: chrome-coated flexible neck, bright LED light, with USB adapter, no external power supply required.

Packing: 100 pcs. / 20 pcs. | Size: 47xØ 1,5cm | Branding:  15x5 mm K2+H4+V2 |  15x10 mm L2+H4



Great sales are
in the wind!

GET FRESH 58-1102440 Desk fan GET FRESH: stainless steel casing, rubberized feet for secure footing, USB cable (length approx. 117 cm) for power supply.

Packing: 30 pcs. | Size: 14,0x15,0x9,5 cm | Branding: ☒ 25x25 mm L2+H4

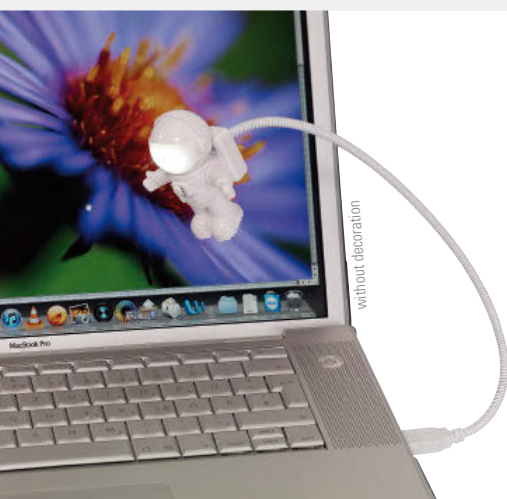

ASTRONAUT 58-8101007 USB light ASTRONAUT: white LED light turns on when the protective visor is lifted up – flexible neck (length approx. 32 cm) with USB connection, in black box.

Packing: 100 pcs. / 25 pcs. | Size: 6,7x6,1x3,8 cm |

Branding: ☒ 12x10 mm K2+H6+V1 | ☒ 12x10 mm L5+H6



Reach for
the stars!





MEM KEY 58-8101001 Key ring accessory MEM KEY with integrated memory stick, capacity 4GB – in the form of a door key, with prominent advertising space.

Packing: 1000 pcs. | Size: 5,5x2,2x0,2 cm | Branding: ☞ 20x7 mm K1+H2+V2 | ☞ 20x7 mm L1+H2

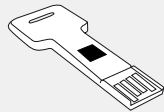

MEM CARD 58-8101002 Key ring accessory MEM CARD with foldout memory stick, capacity 4GB – in the form of a credit card, with prominent advertising space.

Packing: 500 pcs. | Size: 8,3x5,2x0,3 cm | Branding: ☞ 30x35 mm K1+H2+V2 | ☞ 30x35 mm DP1+H2



MEM PEN 58-8101003 Twist-open ballpoint pen MEM PEN, black ink: with integrated memory stick, capacity: 4GB.

Packing: 400 pcs. | Size: 13 x 1,4 cm | Branding: ☞ 35 x 6 mm K2+H4+V2 | ☞ 35 x 6 mm L4+H4 | ☞ Ø7 mm L1+H4

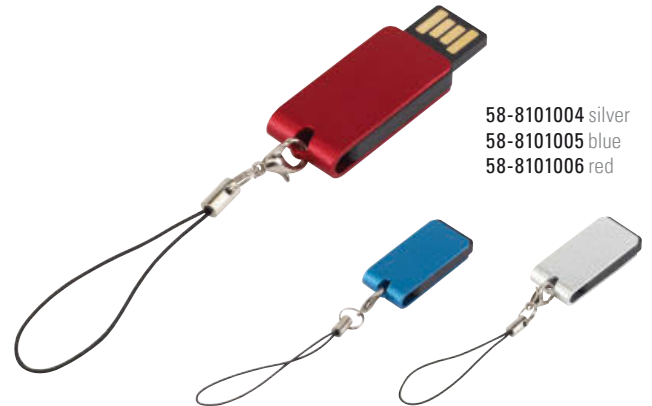

58-8101004 silver
58-8101005 blue
58-8101006 red

MEM FOLD 58-8101004 Key ring MEM FOLD with integrated memory stick and prominent advertising space, capacity: 4 GB.

Packing: 1000 pcs. | Size: 3,5 x 1,6 x 0,7 cm | Branding: ☞ 20 x 9 mm K1+H2+V2 | ☞ 20 x 9 mm L1+H2



Never again will your battery run low.



 NEW

Blue LED battery capacity indication



ENERGY 58-8105008 Powerbank ENERGY – the perfect power supply on the go: suitable for current smartphones and USB devices, on/off switch to check charge level and to start charging, charging starts automatically when connecting device, USB charging cable with micro USB plug (length: approx. 32 cm), with blue LED charge level indicator, input power: 5V/1A, output power: 1. port: 5V/1A, 2. port: 5V/2.1A, capacity: 6.000 mAh, high-performance lithium-ion battery.

Packing: 40 pcs. /10 pcs. | Size: 15x6,8x1,3 cm |

Branding:  70x25 mm K2+H4+V1 |  140x60 mm DP2+H4 |

 100x50 mm L2+H4



With white LED light



MEGAWATT 58-8105002 Portable charger MEGAWATT: for smartphones and external devices, with adapters for iPhone 4, Micro USB, Mini USB - output power: 5 V - 1.000 mA, with integrated white LED light, powerful lithium polymer battery, capacity: 2.200 mAh with blue LED battery level display, incl. USB charging cable (length approx. 22,5 cm), charging time: approx. 7 hours.

Packing: 80 pcs. /20 pcs. | Size: 11,2x6,1x1 cm | Branding:  40x30 mm K2+H4 |

 40x30 mm DP2+H2



Power en route



 NEW

UPGRADE 58-8105006 Powerbank UPGRADE – the perfect power supply on the go: suitable for current smartphones and USB devices, on/off switch to check charge level and to start charging, USB charging cable with micro USB plug (length: approx. 32 cm), input power: 5V/1A, output power: 1. port: 5V/1A, 2. port: 5V/2.1A, capacity: 8.000 mAh, high-performance lithium-ion battery.

Packing: 40 pcs. / 10 pcs. | Size: 8,6x8,2x2,4 cm | Branding: ☹ 45x45 mm K1+H4 | ☹ 50x20 mm DP1+H2 | ☹ 55x55 mm DP2+H4 | ☹ 55x55 mm L5+H4



GIGAWATT 58-8105003 Powerbank GIGAWATT – the perfect energy backup on the go: suitable for smartphones, iPhones, and USB devices, incl. USB cable with several connectors (length: approx. 31 cm), with blue LCD capacity display (remaining power shown in %), input power: 5V/1A, output: port 1 - 5V/1A, port 2 - 5V/2,1A, capacity: 9000 mAh, on/off switch for charging, double click to turn on/off the white LED torch light, high performance lithium-ion battery.

Packing: 40 pcs. / 10 pcs. | Size: 9x7,3x2,3 cm | Branding: ☹ 35x20 mm K2+H4+V2 | ☹ 40x40 mm DP2+H4





 NEW



SOL 58-8105007 Powerbank SOL: suitable for current smartphones and other USB devices – with large solar panel, on switch to check charge level, charging starts automatically when connecting device, 2 USB ports, 1 micro USB port, USB charging cable with micro USB plug (length: approx. 32 cm) – 1) USB mode: input power: 5V/1A, with blue LED charge level indicator, 2) charging via solar panel: input power: 5V, 500 mA, solar charge level indicator with green LED – capacity: 10.000 mAh, output power: 1. port 5V/1A, 2. port: 5V/2.1A, when using both ports simultaneously 5V/1A each, high-performance lithium-polymer-battery.

Packing: 20 pcs. / 10 pcs. | Size: 17,7 x 12 x 0,9 cm |

Branding:  70 x 25 mm K2+H4+V1 |  160 x 90 mm DP2+H2 |

 50 x 20 mm DP1+H4 |  80 x 4 / 80 x 80 mm L2+H4

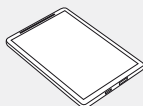



Blue LED battery capacity indication

With touch function



TERAWATT 58-8105004 Powerbank TERAWATT – the perfect energy backup on the go: suitable for smartphones, iPhones, and USB devices, incl. USB cable with several connectors (length: approx. 31 cm), with touch function and blue LED capacity display, input power: 5V/1A, output: port 1 - 5V/1A, port 2 - 5V/2A, capacity: 10.000 mAh, high performance lithium-ion battery, polished metal surface on the back side.

Packing: 40 pcs. / 10 pcs. | Size: 13 x 8,2 x 1,4 cm |

Branding:  40 x 25 mm K2+H4+V2 |  50 x 50 mm DP2+H4



DATABASE 58-8103002 Stainless steel mobile phone holder
 DATABASE – for smartphones and mobile phones: rubber-coated rotary disc allows phone to be positioned horizontally or vertically, with USB hub in the stand.

Packing: 50 pcs. / 25 pcs. | Size: 6,5x7 x 12 cm | Branding:  40 x 10 mm L2+H6

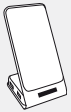



MR. U-TEC 58-8103001 Charger MR. U-TEC – for smartphones and mobile phones: charges via batteries (excl.) and USB cable (length approx. 13,3 cm), with 360° movable arms.

Packing: 200 pcs. / 100 pcs. | Size: 6,9x4,6x2,4 cm | Branding:  20 x 10 mm K2+H4



SPACE 58-1101313 Mobile phone holder SPACE: rubberized adhesive silicone surface, with chrome-plated metal base.

Packing: 100 pcs. / 50 pcs. | Size: 6,6 x 6,4 x 12,5 cm |
 Branding:  40 x 10 mm DP1+H2 |  40 x 10 mm L2+H4



Non-slip silicone surface



STAND BY ME 58-8105000

Mobile phone holder STAND BY ME – for smartphones and mobile phones: with suction cup, ideal for watching movies and looking at photos.

Packing: 1000 pcs. / 250 pcs. | Size: 3,4x4,5x1,9cm |
Branding: ☒ 20 x 10 mm K1+H1



DORADO 58-1101200

Mobile phone holder DORADO: suitable for all mobile phones, glossy chrome sides, advertisement can be applied on front side, made of metal.

Packing: 50 pcs. / 25 pcs. | Size: 7,8x5,8x6cm | Branding: ☒ 30 x 35 mm K2+H6+V2 |
☒ 30 x 35 mm L2+H6



UPRIGHT

Tablet stand UPRIGHT: plastic stand can be folded to save space, silicone corners for good surface adhesion and secure footing.

Packing: 500 pcs. / 250 pcs. | Size: 13,4x4x0,5 cm | Branding: ☒ 40 x 20 mm K1+H2 |
☒ 40 x 20 mm DP1+H2 | ☒ 60 x 20 mm L5+H2

58-8103003 black/white
58-8103004 black



Up to date Time is on our side!

Timepieces: Everyone has one and most people have more than one. There are wall clocks, grandfather clocks, watches, alarm clocks, table clocks and many, many other kinds. Which ones do you prefer? Of course we from PiCOWORLD prefer the extraordinary.



Our unique picotime ideas do not only convince by the exact time - they also stand for contemporary design and multifunctionality. Take some time and see for yourself!



highlight

MACAU 58-0401517 Travel alarm clock MACAU, foldable: with analogue time display, made of shiny metal and leatherette, Battery: 1 coin cell incl.

Packing: 100 pcs. / 50 pcs. | Size: 11/6,3 x 5,2 x 2,8 cm |

Branding:  45 x 20 mm K2+H3 |  35 x 10 mm L2+H3

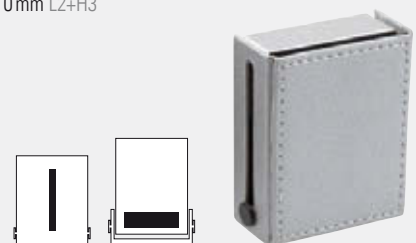



picotime



Water is life! This clock works without batteries.

DEEP BLUE 58-0401332 Table clock DEEP BLUE: digital time display - powered by water and vinegar – with closing lid on top.

Packing: 40 pcs. / 20 pcs. | Size: 10,5x9,5x8,5 cm |
Branding: ☒ 12x6 / Ø20 mm K2+H3

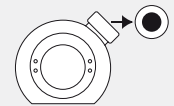

Metal plate for your advertising is affixed with a magnet



AALBORG 58-1101947 Desk clock AALBORG: chrome numerals and hands, cover made of glass, robust stand with skidproof bottom, made of high quality, shiny metal, battery: 1 x AA (excl.).

Packing: 12 pcs. | Size: Ø 16 cm | Branding: ☒ 50x10 mm L2+H3



CIRCLE 58-8044000 Rotating clock CIRCLE: with three platforms: clock, picture frame and printing and engraving area, metal plate for your advertisement is fixed with a magnet, individually arrangeable - lying down or standing, can also be used as a paperweight, 1 button cell SR 66 LR 66 with 1.55 V (incl.).

Packing: 30 pcs. | Size: 5,1 x 2,4 x 10,6/16,2 cm | Branding: ☒ 30x20 mm L2+H6

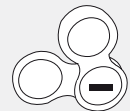

Broadcast your advertisement clear as a bell.

Decorated with 420 rhinestones



With mirror



without decoration

ODENSE 58-1101957 Desk clock ODENSE, foldable: analogue clock and picture frame inside, mirror and 420 rhinestones outside, made of solid stainless steel.

Packing: 24 pcs. | Size: 5,2x5,1x3,8 cm | Branding:  35x35 mm L2+H3

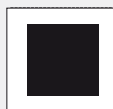

Metal bell as alarm



BELL 58-8044004 Table clock BELL in the shape of a bell tower with analogue time display, white dial and black clock hands, alarm function with metal bell, batteries: 2 x AA (excl.).

Packing: 30 pcs. | Size: 13 x 10 x 5 cm | Branding:  40 x 6 / 20 x 20 mm K2+H4+V2



WESTERN 58-0402070 Alarm clock WESTERN: includes target and gun, the alarm turns off when the target is hit, hitting noises when gun is fired, with recording function and countdown, batteries: 4x AA for target (excl.), 2x AA for gun (excl.).

Packing: 20 pcs. / 10 pcs. | Size: 14,5 x 14 x 4,4 cm | Branding: ☑ 35x20 mm K2+H4



Target with countdown



ICE CLOCK 58-0401345 Designer table clock ICE CLOCK: with alarm clock, time, date and inside temperature shown on lit up display, handmade white ceramic body, Battery: 2x AAA (excl.).

Packing: 20 pcs. | Size: 10 x 8,3 x 4,2 cm | Branding: ☑ 60x20 mm K2+H2+V2



BLACK LINE 58-0401390 Radio controlled clock BLACK LINE: with integrated solar panels, alarm function, snooze, time, date, weekday and temperature display - powered by rechargeable battery and solar energy.

Packing: 50 pcs. / 25 pcs. | Size: 20 x 3,8 x 3,6 cm | Branding: ☑ 40x20 mm K2+H4+V2

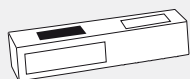

Clocks that do more than simply show the time.



SUNNY TIMES 58-0401870 Weather station SUNNY TIMES: with thermometer, hygrometer, analogue clock and alarm function, all 3 instruments come in rugged metal housing, stand with velvet velour surface, wooden frame with metal plate for your advertisement, battery: 1 x AA (excl.).

Packing: 12 pcs. | Size: 27,5x11,5x3,5cm | Branding: ☒ 50x15 mm DP1+H2 |

☒ 50x15 mm L2+H3



CALOR 58-0401795 Weather station CALOR: with thermometer, hygrometer, humidity and time display, blue LED background lighting, made of white ABS plastic, batteries: 2 x AAA (excl.).

Packing: 50 pcs. / 25 pcs. | Size: 13x9x3,5cm | Branding: ☒ 25x5 mm K2+H3+V1

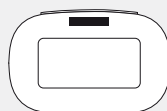

Does almost everything all by itself – the only thing you have to do is read the time!



EXACTLY 58-0401527 Radio controlled wall clock EXACTLY: automatic change from summer to winter time – in accordance to MEZ, displays temperature and humidity, brushed aluminium frame, battery: 1 x AA (excl.).

Packing: 10 pcs. | Size: Ø30 x 4 cm | Branding: ☒ 15 x 12 mm K2+H4+V2 | ☒ 15 x 12 mm L2+H4



Wireless outdoor sensor broadcasts to wall clock

COOL TIME 58-8045000 Wall clock COOL TIME: digital display with inside and outside temperature, wireless infrared sensor transfers data to the clock – sensor with stand (can be used as holder), with smooth quartz clockwork: seconds hand moves without ticking, with aluminium frame, plexiglass, plastic case, batteries for clock and sensor: 3 x AA and 2 x AAA (incl.).

Packing: 10 pcs. | Size: Ø29,9 x 4,2/5,8 x 3,7 x 9,7 cm | Branding: ☒ 15 x 12/35 x 15 mm K2+H4+V2 | ☒ 15 x 12/35 x 15 mm L2+H4



In oversize

RING RING 58-8045001 Alarm wall clock RING RING in oversize:
alarm function, prominent dial, with hook on the backside, metal frame, plexiglass,
plastic back, battery: C/LR14 (incl.).

Packing: 10 pcs. | Size: Ø21,5/21,5x8,8x28,5 cm | Branding: 🗑️ 30x20 mm L2+H6



ROUNDAABOUT 58-0401217 Wall clock ROUNDAABOUT:
aluminium frame and clock-face, with edges wide enough to carry your logo, battery:
1xAA (excl.).

Packing: 10 pcs. | Size: 12,2xØ25 cm | Branding: 🗑️ 40x20 mm L2+H4



Our wallclocks make good times last longer. A logo turns them into eye-catchers!



PUNKTO 58-0400897 Wall-clock PUNKTO: with quartz movement, wide aluminium frame for your advertisement, battery: 1 x AA (excl.).
Packing: 10 pcs. | Size: 3,5 x Ø 35,1 cm | Branding:  50 x 20 mm K2+H4+V1

COUNTRY 58-8045002 Wall clock COUNTRY in retro style: dial with black and red numbers, approx. 8 cm deep plastic frame, with quartz clockwork and robust hook, battery: 1 x AA (incl.).
Packing: 10 pcs. | Size: Ø 30,1 x 10,2 cm |

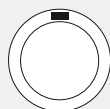

Follow the zeitgeist!



HEMERA 58-0400940 Wall-clock HEMERA: with quartz movement, made from plastic and aluminium, battery: 1 x AA (excl.).

Packing: 20 pcs. | Size: Ø31 x 3,5 cm |



PURIST 58-8045003 Wall clock PURIST: with black-gleaming hands, quartz clockwork, made of bamboo, battery: 1xAA (incl.).

Packing: 10 pcs. | Size: Ø 26 cm | Branding: ☰ 45x25 mm K2+H4

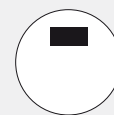

Set the tone Turn up the rich sound!

We say the tone is what makes the music. Whether you are listening to your favourite song from your mobile phone, MP3 player, iPod, iPhone ... only a good sound causes auditory delight. In the search for technical innovations and new sound highlights we are never satisfied with the first-best and pursue the ultimate solutions to meet your and your customers' needs.



Browse through the next few pages and enjoy great entertainment the PiCOWORLD way!

Touch operation

highlight



AQUA-DISC 58-0401850 Shower radio AQUA-DISC, splash-proof: operated by touch, spiral antenna, suction cup for secure attachment, powered by 3xAAA batteries (excl.), made of ABS plastic and acrylic.

Packing: 60 pcs./30 pcs. | Size: Ø 11,3x4 cm | Branding:  30x30mm K2+H4+V1 |  30x30mm DP1+H2

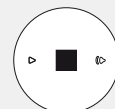



picosound

ICE RADIO 58-0401415 Designed radio ICE RADIO: with retro style knobs to select the station and control the volume, excl. 2xAAA batteries, handmade white ceramic body.

Packing: 24 pcs. | Size: 11,3x9,3x4,9cm | Branding: ☞ 70x20mm K2+H2+V2



SOUNDBALL 58-1101145 Mini radio SOUNDBALL: for mobile phone, iPod, MP3 player and PC, with integrated speaker and connection socket for MP3 players, 4,5 V adapter socket and 3,5mm socket plug, illuminated AM/FM tuning switch and on/off switch, batteries: 3xAAA (excl.).

Packing: 40 pcs. / 20 pcs. | Size: Ø9,5 cm | Branding: ☞ 25x10mm K2+H3



With integrated connection jack for MP3 player

BOOSTER 58-8106003 Interactive speaker BOOSTER with 2 side membranes for the best sound quality, rubberized rest area for a mobile phone or smartphone with volume icons – simply place it on the speaker and the music will be transmitted, AUX cable (approx. 50cm) to connect with PC or laptop, USB cable (approx. 62,5cm) to recharge the batteries, on and off switch on the back, 4 rubber feet.

Packing: 50 pcs. / 25 pcs. | Size: 13x6,9x4,5cm | Branding: ☞ 35x15mm L5+H5



Music through NFC technology



without decoration



BOOM LIGHT 58-8106010 Bluetooth speaker BOOM LIGHT: music output 5 Watt, frequency range: 50 Hz - 20 kHz, Bluetooth version 3.0, range approx. 10 m, to be paired with smartphone, iPhone, MP3 player, tablet etc., also connectable to devices such as PC and laptop through 3,5 mm line-in audio jack (length approx. 57 cm), incl. charging cable with USB plug (length approx. 71,5 cm), plays MP3 via slot for MicroSD card, lamp with touch function, 3 levels of brightness can be set, light power: 160 Lumen (1,6 Watt), powerful rechargeable battery with 1.800 mAh, control keys on base, non-slip coating on bottom and fold-out metal holder to hang up.

Packing: 12 pcs. / 6 pcs. | Size: Ø 12 x 12,5 cm |

Branding: ☑ 35 x 35 mm K1+H4+V1 | ☑ 30 x 30 mm L5+H4



NEW



*With touch function
to set brightness*



without decoration



MICROPHONE 58-8106008 Bluetooth speaker MICROPHONE in retro style: music output 3 Watt, with Bluetooth version 3.0, approx. 10 m range, to couple with cell phone, Bluetooth MP3 player, tablet etc., charging cable with USB connector included, integrated speakerphone, rechargeable battery with 600 mAh capacity, control buttons in stand.

Packing: 20 pcs. / 10 pcs. | Size: 18xØ9,2 cm | Branding:  25x15 mm L2+H4





BLUEDANCE 58-8106002 Mini speaker BLUEDANCE: for mobile phone, iPhone, MP3 player and PC, with blue light that dances to the rhythm of the music, frequency range: 150 Hz - 20 KHz, incl. cable with USB and line-out port 3,5 mm jack (length approx. 83 cm), with rechargeable built-in battery.

Packing: 100 pcs. / 25 pcs. | Size: Ø5x5,6 cm |

Branding:  160x30 mm LR3+H4 360° |  30x5 mm L2+H4



MUSH 58-8106009 Car Bluetooth speaker MUSH: music output: 3 Watt, with Bluetooth version 3.0, to be paired with mobile phone, Bluetooth-MP3-player, tablet etc., can be connected to external devices through 3,5 mm line-in audio jack (cable length: approx. 50 cm), slot for micro SD card, plays MP3s, with hands-free function, max. range: approx. 10 m, colourfully illuminated control keys, powerful battery, capacity: 600 mAh, USB charging cable with micro USB plug (length: approx. 50 cm) included, runtime: approx. 3 - 4 h, charging time: approx. 1 h, on / off switch at base, rubberized bottom with screw thread for suction cups (incl.) to attach to smooth surfaces, fancy metal casing.

Packing: 40 pcs. / 20 pcs. | Size: Ø7,4x6,7 cm | Branding:  20x25 mm K2+H4+V1 |  30x20 mm L1+H4



 **NEW**

With hands-free function





AUDIOMAX 58-8106004 Bluetooth stereo speaker AUDIOMAX: music output 2x3 Watt, with Bluetooth version 3.0, approx. 10 m range, to couple with cell phone, Bluetooth MP3 player, tablet etc., can also be connected to external devices such as PC and laptop, MP3 player, through line-in jack (3,5 mm), incl. charging cable with USB connection, plays MP3 also via slot for MicroSD card and USB stick (card and stick excl.), FM radio with autoscanner function and station memory presents, with speakerphone, integrated rechargeable battery with 1200 mAh capacity, control buttons at the top, 2 bottom rubber feet for best surface hold, metal plate on the front for your advertising, packed in gift box.

Packing: 30 pcs. / 10 pcs. | Size: 27,7 x 4,3 x 5,8 cm |

Branding: ☒ 35 x 10 mm K2+H6+V1 | ☒ 35 x 10 mm L2+H6

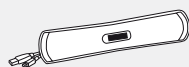

Adjustable microphone boom to optimally position microphone



ROSKILDE 58-1101880 Headset ROSKILDE: rotatable and adjustable microphone boom, soft padded headband and earpieces, volume control, 3,5 mm phone connector with cable (length approx. 2,2 m), frequency range: 8 - 22.000 Hz, sound pressure level: 100 dB.

Packing: 40 pcs. / 10 pcs. | Size: 21 x 6,8 x 8,5 cm | Branding: ☒ 40 x 6 mm K2+H4



VIBORG 58-1101897 On-ear headset VIBORG: soft padded headband and earpieces, built-in microphone at the volume control, 3,5 mm phone connector with cable (length approx. 2,2 m), frequency range: 8 - 22.000 Hz, sound pressure level: 100 dB.

Packing: 40 pcs. | Size: 18 x 17,5 x 7 cm | Branding: ☒ 30 x 5 mm K2+H4





58-8106005 black
58-8106006 white
58-8106007 red

WACKEN Headphones WACKEN: can be folded to save up space – soft padded headband and earphones, 3,5 mm stereo jack plug with cable (length approx. 155 cm), frequency range: 50 Hz - 20 kHz, volume: 110 dB +/- 3 dB.

Packing: 20 pcs. | Size: 18 x 18 x 6,5 cm | Branding:  15 x 15 / 30 x 15 mm K1+H4+V1



HURRICANE 58-1102260 On-ear headphones HURRICANE: cushioned earphones, volume control, 3,5 mm connector with cable (length approx. 2,2 m), frequency range: 8 - 22.000 Hz, sound pressure level: 100 dB, made of white plastic.

Packing: 40 pcs. | Size: 20 x 14,5 x 6 cm | Branding:  25 x 5 mm K2+H4

SOUNDCHECK 58-1103010 On-ear headphones SOUNDCHECK: cushioned earphones, adjustable headband with leather design, volume control, 3,5 mm phone connector with cable (length approx. 2,10 m), frequency range: 20 Hz - 20.000 Hz, sound pressure level: 105 dB.

Packing: 40 pcs. | Size: 20,0 x 15,2 x 7,1 cm | Branding:  35 x 15 mm K2+H4



Pleasure for eyes and ears

FREESPORT 58-8106001 Bluetooth headphones FREESPORT, splash-proof: ear cups with player function, runtime: approx. 8 hours, can be used as headset thanks to built-in microphone, Bluetooth version 2.0, with integrated battery, charging via incl. USB cable (length approx. 48 cm).

Packing: 20 pcs. | Size: 13 x 14 x 4,1 cm | Branding:  20 x 10 mm K2+H4



Turnable and foldable headphones



CONCERT 58-1103014 MP3 headphones CONCERT: rotatable and foldable headphones, cushioned earphones with player function and slot for micro SD card, memory capacity: up to 16 GB (excl.), supported music file format: MP3, frequency range: 20 Hz - 20.000 Hz, sound pressure level: 108 dB, battery chargeable via USB cable (length approx. 96 cm).

Packing: 40 pcs. | Size: 18 x 15 x 5,5 cm | Branding:  30 x 20 mm K2+H4



Padded headphones

Slot for mini SD card

Player function

With printing and engraving area



Brilliant performance Shown in the best light!

Let it shine. Our LED lights do not only look good, in terms of light output they are really small power packs. Reading light, solar lantern or flashlight ensure optimum illumination, wherever it is needed. The LEDs make it possible. In contrast to the light bulbs they are also much less sensitive to vibrations.

We from PiCOWORLD are specialised in bringing good things to light. You and your clients will be absolutely thrilled by the multifunctional picolux ideas!



2 removable torches (3x AAA batteries each, excl.)

highlight

TRANSFORMER 58-0600650 Camping lantern

TRANSFORMER: 2 light windows with integrated removable flashlights, retractable carrying handle, rechargeable via 230-volt outlet connector or 12-volt outlet (cigarette lighter), rubberized on/off switch.

Packing: 6 pcs. | Size: 25 x 12 cm | Branding: ☞ 30 x 10 mm K2+H5





Save energy
for a rainy day.

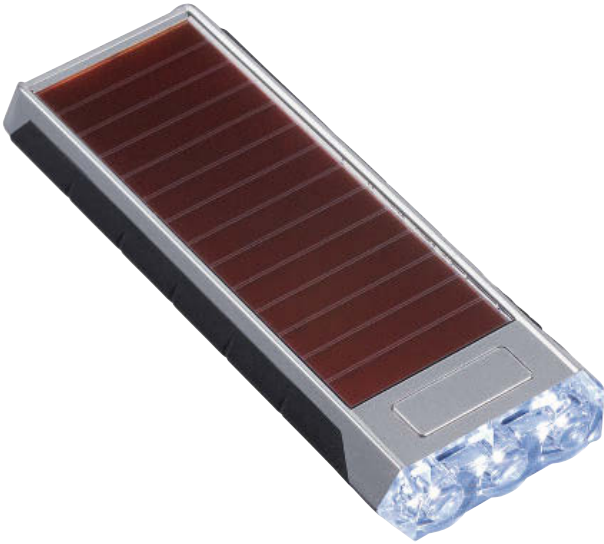

FLASHLIGHT 58-0600397 Dual-power torch FLASHLIGHT: with solar panel, 3 white LED lights and rechargeable lithium battery, plastic case.

Packing: 100 pcs./25 pcs. | Size: 11,5x4,5x1,5 cm | Branding: ☒ 15x5 mm K2+H2

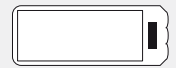

CORDLIGHT 58-0600497 Dual-power torch CORDLIGHT: with solar panel on top, dynamo function, 3 white LED lights, rechargeable lithium battery, plastic casing.

Packing: 100 pcs./25 pcs. | Size: 13x4,8x1,7 cm | Branding: ☒ 16x4 mm K2+H2



A reliable light source without batteries. A must-have for every driver!

ELECTRA 58-0600657 LED torch ELECTRA: handle can be unscrewed, rechargeable via 12-volt outlet (cigarette lighter), rubberized grip and on/off switch, robust stainless steel casing.

Packing: 50 pcs. | Size: 16x3,2cm | Branding: ☞ 20x10mm L2+H4

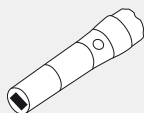

Rechargeable via 12 Volt adapter (cigarette lighter)



TURNLIGHT 58-0600590 Dual-power torch TURNLIGHT: with solar panel, dynamo lever, integrated rechargeable battery, 3 white LEDs, wrist strap, on/off switch on the side, plastic casing.

Packing: 120 pcs. / 60 pcs. | Size: 9x5x3cm | Branding: ☞ 20x5mm K2+H2



GÉNÉRATEUR 58-0600140 Dynamo torch GÉNÉRATEUR: dynamo lever, integrated rechargeable battery, 3 white LEDs, supporting loop, on/off switch at the side, made of high quality plastic.

Packing: 100 pcs. / 25 pcs. | Size: 7,4x4,4x2,7cm | Branding: ☞ 40x30mm K2+H4 | ☞ 50x30mm DP2+H2

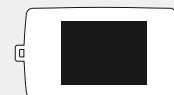

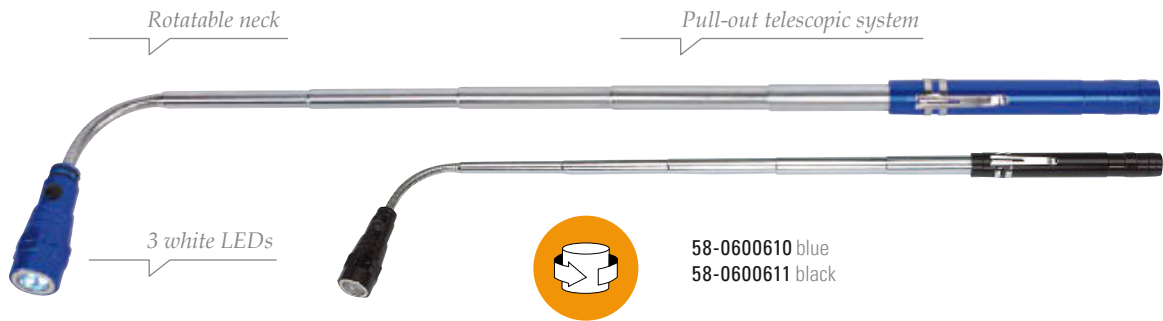

58-0600610 blue
58-0600611 black

REFLECT

LED torch REFLECT: telescoping neck extendable up to approx. 55 cm, rotating light, 3 white LEDs, magnetic ring, practical clip, rubberized on/off switch, aluminium casing, batteries: 4 x LR44 (incl.).

Packing: 100 pcs. / 25 pcs. | Size: Ø 2 x 16,8 cm | Branding: 30 x 4 mm K2+H4+V2 | 30 x 4 mm L2+H4 | 50 x 50 mm LR2+H4 360°



Rubber-coated ON/OFF button



With practical clip

With ring magnet



3 light modes



With magnet function

FLASH

58-8063002 LED torch FLASH: 7 white and 3 red LED lights in torch head, 18 white and 6 red LED lights in the handle – 3 light modes – with magnet at the torch end, rubber-coated on/off button, light and robust aluminium housing with nylon hand strap, batteries: 3x AAA (excl.).

Packing: 50 pcs. / 25 pcs. | Size: Ø 3,6 x 19,5 cm | Branding: 10 x 12 / 40 x 9 mm L2+H4

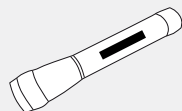



58-8064001 blue/black
58-8064002 red/black



Adjustable light cone for wide vision or for focussing

Be a guiding light



ZOOM LED torch ZOOM: with white light, adjustable light cone (wide angle or focused), shiny matt metal surface, rubberized on/off switch, with nylon supporting loop, aluminium lamp, batteries: 3 x AAA (excl.).

Packing: 50 pcs. / 25 pcs. | Size: Ø3 x 10,5-11,5 cm | Branding: 🗑️ 30 x 10 mm L2+H4

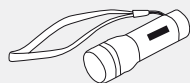

SHINING 58-8064003 LED torch SHINING: in robust aluminium body, rubberized on/off button, with clip to attach, batteries: 3 x LR44 (incl.).

Packing: 300 pcs. / 50 pcs. | Size: Ø2,2 x 7,2 cm | Branding: 🗑️ 17 x 7 mm K1+H2+V2 | 🗑️ 15 x 7 mm L1+H2

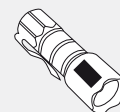

58-8041001 anthracite
58-8041002 turquoise
58-8041003 magenta
58-8041004 green



Rechargeable via USB



CARA Mini torch CARA: 6 strong white LED lights, rubberized on/off switch, with carabiner to attach to key ring, made of light aluminium, 4 button cells LR 44 (incl.).

Packing: 200 pcs. / 50 pcs. | Size: Ø2,5 x 5,7 cm | Branding: 🗑️ 20 x 5 mm L2+H4

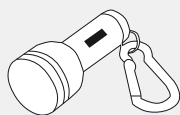

CHARGER 58-8041005 LED light CHARGER, chargeable: with key ring and integrated USB port for charging.

Packing: 400 pcs. / 200 pcs. | Size: Ø2,2 x 5,3 cm | Branding: 🗑️ 20 x 10 mm K1+H2 | 🗑️ 20 x 8 mm L4+H2

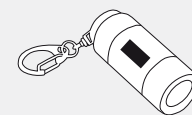



Tilting mechanism changes the lighting angle

Our PiCO reading lights are pretty bright.



Z-FLEX 58-8116001 USB desk lamp Z-FLEX, foldable: with 16 white LED lights, USB charging port, USB cable (length approx. 119 cm), on/off switch on the side.

Packing: 50 pcs. / 25 pcs. | Size: 18 x 4 x 2,5 cm | Branding: ☑ 45 x 15 mm K2+H5+V2 | ☑ 150 x 20 mm DP2+H5

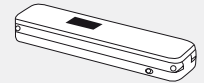



READ 58-1101120 LED lamp READ: provides ideal reading light, with bookmark function, made of flexible rubber and plastic.

Packing: 120 pcs. / 60 pcs. | Size: 20,2 x 4,1 x 1,4 cm | Branding: ☑ 30 x 20 mm K2+H4+V2





SWAN 58-8116003 Desk lamp SWAN: flexible swivel lighting arm with 14 LEDs, dimming function with 3 brightness levels, touch sensitive on/off, powered through a USB cable (length 120 cm), versatile in use thanks to integrated battery, power consumption up to 1,5 Watt, stand with rubber feet for best surface hold, packed in gift box.

Packing: 30 pcs. / 15 pcs. | Size: 11 x 10 x 28 cm | Branding:  30 x 16 mm K2+H6+V1 |  30 x 16 mm L4+H6



*Flexible and turnable
spotlight with 25 LEDs*

ILLUMINATION 58-1103035 Desk lamp ILLUMINATION: individually adjustable pivot arm with 25 LEDs, continuously adjustable dimming, switched on/off by touching the base, power supply via 230 volt socket outlet and USB cable (length approx. 182 cm), rubberized surface.

Packing: 10 pcs. | Size: 38 x 11 x 11 cm |

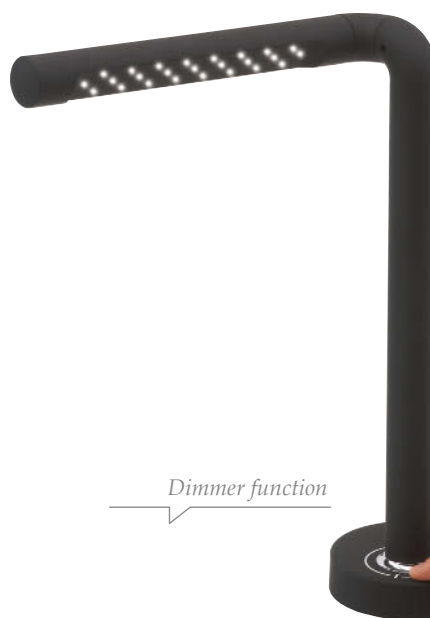

Dimmer function

Spark of inspiration Is it hot enough for you?



When was the last time you were actually in love? Our lighters will certainly light your fire. It's love at first sight! Even if you and your customers are not smoking, you will simply love our lighters. Wherever they are used, the heat is on.

Enjoy these innovative picoflam ideas that will spark off both you and your customers!



highlight

SKYSCRAPER 58-0400497 Stick lighter SKYSCRAPER: with child-proof lock, small control wheel to adjust the flame size, refillable gas filled, made of metal.

Packing: 200 pcs. | Size: 17,6x1,5x1,1 cm | Branding:  20x7 mm K2+H4+V2 |  20x8 mm L2+H4





pico**flame**

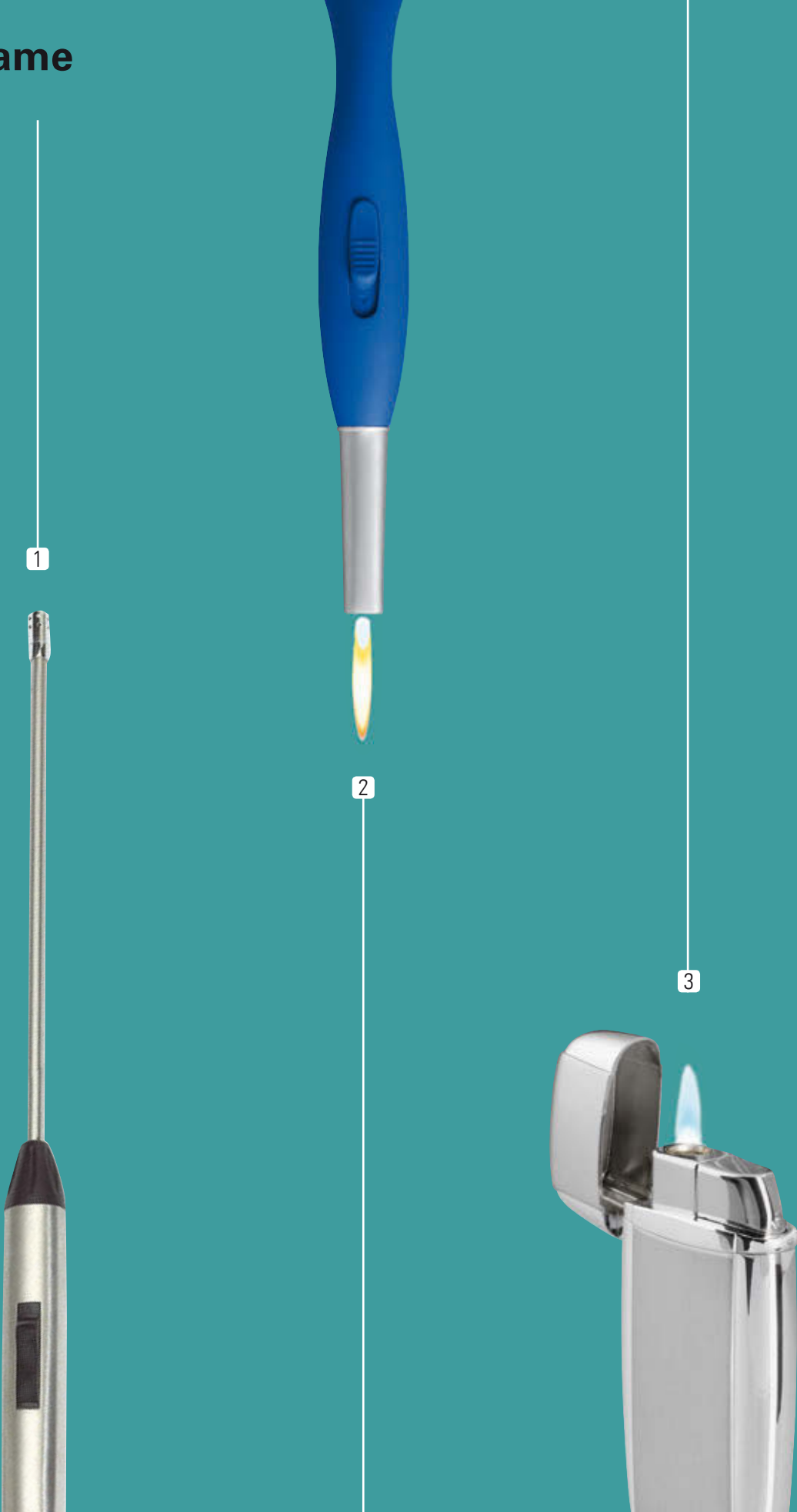



1 FIRESTARTER 58-8043000 Stick lighter FIRESTARTER: approx. 29 cm long neck, on/off switch with child protection, flame adjusting wheel, refillable gas filled, with instruction manual in different languages.

Packing: 50 pcs. | Size: 2,9x2,3x47,9 cm | Branding: ☹ 30x10 mm K2+H4+V1 | ⚡ 30x10 mm L2+H4

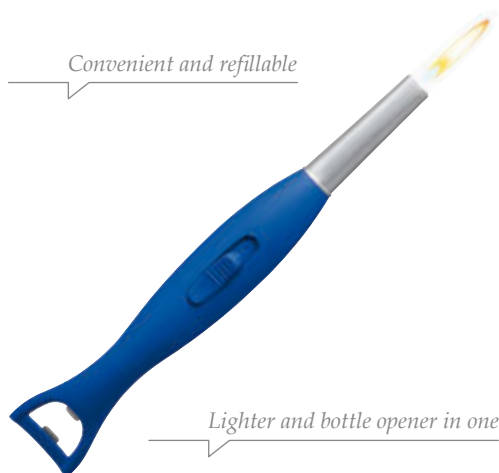

2 DOLPHIN 58-0400552 Stick lighter DOLPHIN: with integrated bottle opener, child-proof lock, small control wheel to adjust the flame size, refillable gas filled, made of plastic.

Packing: 100 pcs. | Size: 23x3,9x3 cm | Branding: ☹ 40x6 mm K2+H2+V2 | ⚡ 40x5 mm L2+H2



3 COMTE 58-0400567 Flameless piezo ignited lighter COMTE: high quality stainless steel surface, refillable gas filled, delivered in quality gift box.

Packing: 100 pcs. | Size: 7x3,3x1,1 cm | Branding: ☹ 40x15 mm K2+H2+V2 | ⚡ 40x25 mm L2+H2



Time off

Relaxing, practical, and super active!

Everybody needs a portion of leisure. Simply no appointments, computer and cell phone are turned off. Start your barbecue and simply relax. Or meet up with friends for a picnic in the park. However you use your free time, just think of yourself. After all, less stress brings more joy to life!

The picoactive-program offers you a lot of variety in every season. We have put together ideas for you and your customers which simply invite you to unwind.



highlight

SOL-SPOT 58-0600437 Solar lamp SOL-SPOT: with bright LED light, integrated solar panel, robust plastic pole, shiny metal casing.

Packing: 30 pcs. | Size: 37 x 14 x 9 cm | Branding:  35x20 mm L2+H5

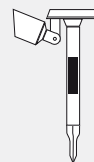



picoactive



The meat and potatoes of every barbecue.



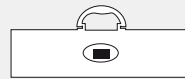

GRILLINO 58-0600227 BBQ set GRILLINO, 3 pcs: fork, spatula and tongs made of stainless steel, all pcs with long handle, in aluminium cases with 2 snap locks, grip and metal plate for your advertisement.

Packing: 10 pcs. | Size: 38 x 11 x 9 cm | Branding:  60 x 30 mm L2+H4



GRILLINATOR 58-0600230 BBQ set GRILLINATOR, 5 pcs: tongs, fork, spatula, salt and pepper shakers made of stainless steel, in handy nylon apron with integrated belt pouch and snap lock.

Packing: 10 pcs. | Size: 38 x 20 x 5,5 cm | Branding:  30 x 10 mm K2+H4+V2 |  80 x 80 mm T1+H6/T2+H6 |  10 x 10 mm L2+H4

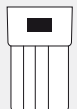

Let the barbecue season begin!



GRILLMEISTER 58-0600217 BBQ set GRILLMEISTER, made of stainless steel, 21 pcs: spatula, brush, knife, grill brush, fork, tongs and extra brush, salt and pepper shakers, 8 corn cob holders, 4 spits. Aluminium case with 2 snap locks, metal plate on case for your advertisement.

Packing: 5 pcs. | Size: 47,1 x 29 x 7,5 cm | Branding: 🗑️ 60 x 30 mm L2+H4

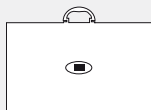

BBO-CADDY 58-0600290 BBQ set BBO-CADDY, 7 pcs: spatula, tongs, grill brush, brush and fork, plastic handles in the design of golf clubs, salt and pepper shakers in the design of golf balls, in caddy bag made of leatherette.

Packing: 6 pcs. | Size: 50 x 15 cm | Branding: 🗑️ 50 x 10 mm K2+H6+V2 | 🗑️ 50 x 30 mm T2+H6 | 🗑️ 50 x 30 mm L2+H4



COOLNESS 58-8065001 Picnic shoulder bag COOLNESS: with 3 pockets – 1 zip pocket, 1 aluminium isolation compartment for drinks and food, 1 extra zip compartment containing tongs, fork, spatula, salt and pepper shaker, bottle opener, cutting board and knife, made from 420D diamond and 840D jacquard. Packing: 6 pcs. | Size: approx. 30 x 17 x 40 cm | Branding:  120 x 40 mm T2+H4



KILTY 58-0600503 Picnic blanket KILTY, foldable: warm top side made of 100% polyester, with stain-resistant underside made of PVC, incl. bag made of 600D polyester. Packing: 20 pcs. | Size: 38 x 28 x 5 cm / 150 x 117,5 cm | Branding:  80 x 80 mm T2+H2



Back side of blanket with stain-resistant PVC coating



SUMMERTIME 58-0600309 Picnic bag SUMMERTIME: made of polyester, for 2 persons, 2 zip pockets, one insulated compartment for drinks and food, second compartment includes 2 cups, salt and pepper shaker, 2 sets of cutlery, 2 plates, 1 cutting board, 1 bottle opener with cutters and corkscrew and 1 vacuum flask made of stainless steel. Packing: 6 pcs. | Size: 37 x 29 x 15 cm | Branding:  100 x 60 mm T2+H2



Suitable for 2 people



Enjoy life and be spontaneous.
How does that work? See for yourself!



Suitable for 4 people

4 PICKNICK 58-0600519 Picnic bag 4 PICKNICK for 4 persons: zip bags at the side filled with 4 plastic plates and glasses, metal spoons, forks and knives and napkins each, a waiter's knife, isolated zip cooler pocket for drinks and food, incl. picnic blanket (135 x 113 cm) with stain-resistant underside, adjustable and removable shoulder straps, 2 carrying handles.

Packing: 4 pcs. | Size: 45x25x24 cm |



Suitable for 4 people

COOLNESS 58-8065000 Picnic backpack COOLNESS for 4 people: contains 4 cloth napkins, plates, glasses, knives, forks, spoons each, 1 salt and pepper shaker, 2 bottle opener, 1 cutting board and knife, with aluminium isolation compartment for drinks and food, made from 420D diamond and 840 jacquard.

Packing: 6 pcs. | Size: approx. 30 x 17 x 40 cm | Branding:  100 x 30 mm T2+H4



FAXE 58-0200110 Shopping bag FAXE: with integrated cooler compartment, hook to hang on the trolley, can be rolled up to save space, polyester and aluminium lining on the inside.



Packing: 40 pcs. | Size: approx. 24-34 x 32,5-48 x 39 cm |
Branding:  80 x 80 mm T2+H2



without decoration



CUORE Shopping bag CUORE: with long handles, can be folded to form a heart shape, made of polyester.

Packing: 100 pcs. / 10 pcs. | Size: approx. 41 x 37 cm |
Branding:  30 x 25 mm T2+H2 |  30 x 25 mm S2+H2



58-0200140 black
58-0200141 red
58-0200142 blue



PERSONAL-ALARM 58-0400650 Key ring PERSONAL-ALARM: noisy audio warning sounds if you pull out the ring, handbag sized.

Packing: 100 pcs. | Size: 13,5 x 3,8 x 2,7 cm | Branding:  20 x 10 mm K2+H2





CASH CHECK 58-8041101

Money clip CASH CHECK with large advertising area, made of solid metal, packed in a gift box.

Packing: 240 pcs. /60 pcs. | Size: 5,8x3x1 cm | Branding: ☞ Ø22 mm D1+H2 | ☞ 15x15 mm K1+H2+V2 | ☞ 15x15 mm L1+H2



HOLD IT 58-0401477

Hand bag holder HOLD IT, foldable: felt underside provides secure hold on even surfaces, upper side ideal for placing your advertisement, made of shiny metal, delivered in case.

Packing: 250 pcs. /50 pcs. | Size: Ø4,5x0,8 cm | Branding: ☞ Ø25 mm K2+H2+V2 | ☞ Ø25 mm DP1+H2 | ☞ 23x23 mm L1+H2



HOLD IT FOREVER 58-0401827

Hand bag holder HOLD IT FOREVER, foldable: with integrated mirror, rubberized underside provides secure hold on even surfaces, fastener with 2 magnets, upper side ideal for placing your advertisement, made of zinc cast and stainless steel, delivered in case.

Packing: 200 pcs. /50 pcs. | Size: Ø4,5x1,3 cm | Branding: ☞ Ø25 mm K2+H2+V2 | ☞ 20x20 mm DP1+H2 | ☞ Ø25 mm L1+H2



 NEW





2 in 1



You can find additional powerbanks on pages 448-449.



HOT POWER 58-8105005 Powerbank HOT POWER with integrated heat source: suitable for smartphone, iPhone, and USB devices, incl. USB charging cable with micro-USB connector (length: approx. 30 cm), input power: 5V, 500 mA, output power: 5V, 1000 mA, charging time: approx. 4 h, capacity: 2200 mAh, high-performance lithium-ion battery, robust and lightweight aluminium casing – pocket heater gives heat of 45° C for approx. 3 h – simple to switch on and toggle powerbank and heater through single button.

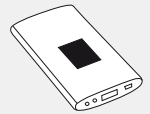

Packing: 80 pcs./20 pcs. | Size: 9,8x5,7 x 1,4 cm |
Branding:  70x25 mm K2+H4+V1 |  85x35 mm DP2+H4



Battery rechargeable via USB



HEAT 58-0600527 Hand warmer HEAT: provides heat up to 40° C upon pressing the button, rechargeable via USB cable (length approx. 32 cm), with integrated Li-Ion battery, made of plastic and aluminium.

Packing: 100 pcs./20 pcs. | Size: 9,1x4x0,8 cm |
Branding:  40x20 mm K2+H4+V1 |  90x35 mm DP2+H2 |  40x25 mm L2+H4



We won't leave you
and your customers
high and dry!

BOTTICELLO Drinking bottle BOTTICELLO, made of aluminium: with carabiner, capacity approx. 0,5 litre, incl. closable neoprene bag for cooling.
Packing: 40 pcs. / 20 pcs. | Size: Ø7,3x19,5 cm | Branding: ☒ 40x20 mm K2+H2+V2 | ☒ 40x20 mm T1+H4 | ☒ 225x60 mm LR3+H4 360° | ☒ 40x20 mm L2+H7



Capacity approx. 0,5 litres



58-0600342 blue/black
58-0600347 silver/black

58-0600450 black
58-0600451 red
58-0600452 blue



Capacity approx. 0,5 litres

58-8034000 white/silver
58-8034001 blue/silver
58-8034002 red/silver



Capacity approx. 450 ml

KEGEL Elegant vacuum flask KEGEL: capacity approx. 0,5 l, made of stainless steel.
Packing: 24 pcs. / 12 pcs. | Size: Ø7,5x25 cm | Branding: ☒ 30x30 mm K2+H4+V2 | ☒ 230x60 mm LR3+H4 360° | ☒ 28x28 mm L2+H4



WARMING UP Vacuum flask WARMING UP, double-walled: ideal for hot and cold drinks, cap with mouthpiece, coated bottom for good surface adhesion, capacity approx. 450 ml.
Packing: 48 pcs. | Size: Ø7,5x22,3 cm | Branding: ☒ 20x22 mm L2+H4 | ☒ 220x60 mm LR3+H4 360°



BRIGHTHEAD 58-0600117 Head lamp BRIGHTHEAD: with 5 LED lights, narrow and adjustable headband, weighs only 20 g, made of plastic, 5xLR41 batteries (incl.).

Packing: 200 pcs./10 pcs. | Size: 4,5x4x1,8cm | Branding: ☒ 20x20mm K2+H2



KILIMANDSCHARO 58-0600127 Head lamp KILIMANDSCHARO: with 12 LEDs, bulb lifetime of around 100.000 hours, adjustable lighting by turning on 4, 8 or 12 bulbs together with an intermittent option, adjustable headband for high wearing comfort, made of plastic, batteries: 3xAAA (excl.).

Packing: 100 pcs./10 pcs. | Size: 7x5,5x6,5cm | Branding: ☒ 6x8mm K2+H2

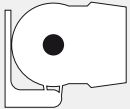

12 LED lights for 100.000 hours of durability

Intermittent lighting option

TREKKING 58-0600167 Compass TREKKING: magnified field for better reading of degrees as well as thread and magnifier with notch for direction finding, rotatable rose bedded in liquid, silver-coloured metal casing.



Packing: 100 pcs./20 pcs. | Size: 8x6x3 cm | Branding: ☒ 30x8mm K2+H2+V2 | ☒ 30x6mm L2+H2



Sharp tools to go

SAURUS 58-0300257 Multifunctional tool SAURUS, made of stainless steel: with foldable pair of pliers, knives, slotted and crosstip screwdrivers, saw, file, bottle opener and awl, comes in nylon pouch with Velcro closure and belt loop, total weight: approx. 265 g.

Packing: 40 pcs. /5 pcs. | Size: 10,6x5,2x1,6 cm |

Branding:  40x8 mm K2+H5+V1 |  40x8 mm L2+H5

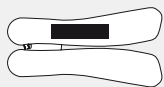

EXTREME 58-0300830 Pocket knife EXTREME: with 11 tool functions: knife, can opener, corkscrew, bottle opener, slotted and crosstip screwdrivers, scissors, wood saw, awl, file, fish knife, rubberized grip with two metal plates for your advertising, total weight: approx. 122 g.

Packing: 80 pcs. /20 pcs. | Size: 10x3,1x2,2 cm | Branding:  20x5 mm L2+H2



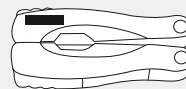

JOB SHOP 58-0300870 Multifunctional tool JOB SHOP: foldable universal pliers, aluminium grips in which stainless steel tools can be found: saw, file, slotted and crosstip screwdrivers, fish knife + scale (cm + inch), can opener, knife blade, awl, delivery in nylon pouch with Velcro closure and belt loop, total weight: approx. 240 g.

Packing: 40 pcs. /10 pcs. | Size: 10x4,5x2,0 cm | Branding:  20x5 mm L2+H5





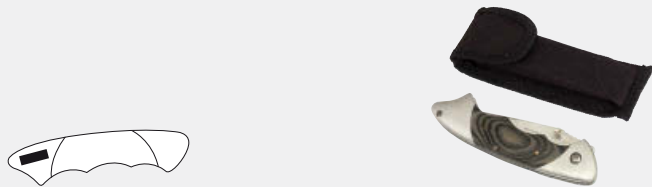

PRESTIGE 58-0300909 Pocket knife PRESTIGE, foldable: stainless steel blade, belt clip, smooth grip with grained wood application, incl. nylon bag with Velcro closure and belt loop, delivered in case, total weight: approx. 139 g.
 Packing: 96 pcs. / 12 pcs. | Size: 11,2x2,8x1,7 cm |
 Branding:  40x10 mm K2+H6+V1 |  15x5 mm L2+H6



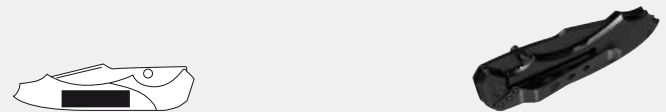

BLACK-CUT 58-0300560 Pocket knife BLACK-CUT, foldable: steel blade with electrophoresis procedure finish, with clip and safety fuse, ergonomic grip, total weight: approx. 129 g.
 Packing: 48 pcs. / 12 pcs. | Size: 19,2x3,6x1,8 cm | Branding:  40x10 mm L2+H3



OUTBACK 58-0300810 Pocket knife OUTBACK, foldable: stainless steel blade, belt clip, slip-proof surface structure, total weight: approx. 109 g.
 Packing: 80 pcs. / 20 pcs. | Size: 11,0x3,0x1,9 cm | Branding:  30x4 mm L2+H4



MA-BU 58-0300542 Cutter knife MA-BU, foldable: easy to change manganese blade, incl. 5 spare blades in transparent box, ergonomic grip, belt clip, total weight: approx. 86 g.
 Packing: 100 pcs. / 25 pcs. | Size: 10x3,8x1,7 / 15,8x2,9x1,6 cm |
 Branding:  50x10 mm K2+H3+V1 |  50x13 mm L2+H3

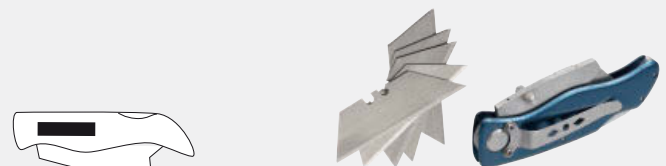



QUANTUM 58-8062000 Ultrasonic distance measurer QUANTUM: volume (m³) and area (m²) calculations, adds up to 20 length measurements, measurement range: approx. 0,13 m - 15 m, with digital display, on/off switch at the side and ergonomic grip, battery: 9 V monobloc battery (incl.).

Packing: 100 pcs. / 10 pcs. | Size: Ø5 x 13 cm | Branding: ☒ 30 x 10 mm K2+H4



INDEX 58-8062002 Measuring tape INDEX with finger protection, automatic, with stopper, individually adjusted belt clip for right- and left handed persons on the back, rubberized casing with metal plate for your advertising, 5 m.

Packing: 48 pcs. / 12 pcs. | Size: 10 x 8 x 4 cm | Branding: ☒ 30 x 35 mm K2+H4+V2 | ☒ 30 x 35 mm DP1+H2 | ☒ 30 x 35 mm L2+H4

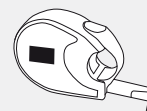

Robust 2m steel measuring tape

58-0300710 blue/silver
58-0300730 black/silver
58-0300750 red/silver



DISTANCE Measuring tape DISTANCE, 2 m: robust steel tape, scale in cm and ft, with carabiner for attachment to belt or keychain, printing and engraving area on both sides.

Packing: 200 pcs. / 50 pcs. | Size: 6,6 x 4,7 x 1,8 cm | Branding: ☒ 20 x 10 mm K1+H4



Good to go Comfort around the globe!



Anyone who travels a lot, knows how important it is to pack smartly. It starts with the manicure set and does not end with a hanger. And a luggage tag makes sure that the bag always finds its way back to the owner. Wherever your travels take you, we from PiCOWORLD offer you and your customers the best comfort.

Begin your next trip with our picotravel ideas. And don't forget: Make sure you use our logo services to bestow your personal and individualized return address on each and every product.



highlight

Y-POWER 58-8063001 USB car charger Y-POWER: permits simultaneous charging of two devices via cigarette lighter (12/24 V contact), two hubs, output power: 5 V, 2.000 mA, charges most current smartphones, digital cameras and MP3 players.

Packing: 200 pcs. / 50 pcs. | Size: 8,5 x 5 x 2 cm |
Branding:  40 x 10 mm K1+H4 |  40 x 10 mm DP1+H2 |
 40 x 10 mm L4+H4



without decoration





picotravel

With extensive menu options

films at 120° angle



Picture perfect.

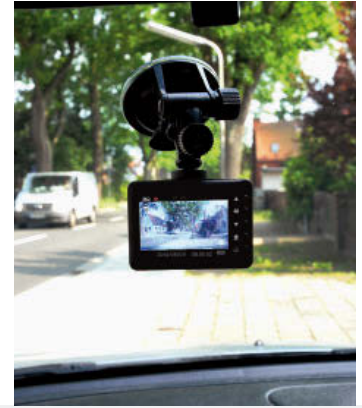

EVIDENCE 58-8107001 Digital car camera EVIDENCE for spectacular shots while driving: films night and day in full-HD quality – with continuous loop recording, motion sensor and photo function – equipped with microphone, TF memory card slot (supports memory cards up to 32 GB – memory card excl.), HDMI and USB 2.0 ports – includes suction cup to fix to the windscreen, 12- and 24-Volt power supply car adapter, with USB cable for data transmission, packed in giftbox.

Packing: 24 pcs. | Size: 7,6x5,6x2,2 cm | Branding:  25x3/25x5 mm K2+H6





With hands-free function

 NEW



MUSH 58-8106009 Car Bluetooth speaker MUSH: music output: 3 Watt, with Bluetooth version 3.0, to be paired with mobile phone, Bluetooth-MP3-player, tablet etc., can be connected to external devices through 3,5 mm line-in audio jack (cable length: approx. 50 cm), slot for micro SD card, plays MP3s, with hands-free function, max. range: approx. 10 m, colourfully illuminated control keys, powerful battery, capacity: 600 mAh, USB charging cable with micro USB plug (length: approx. 50 cm) included, runtime: approx. 3 - 4 h, charging time: approx. 1 h, on/off switch at base, rubberized bottom with screw thread for suction cups (incl.) to attach to smooth surfaces, fancy metal casing.

Packing: 40 pcs. / 20 pcs. | Size: Ø7,4x6,7 cm |

Branding:  20x25 mm K2+H4+V1 |  30x20 mm L1+H4



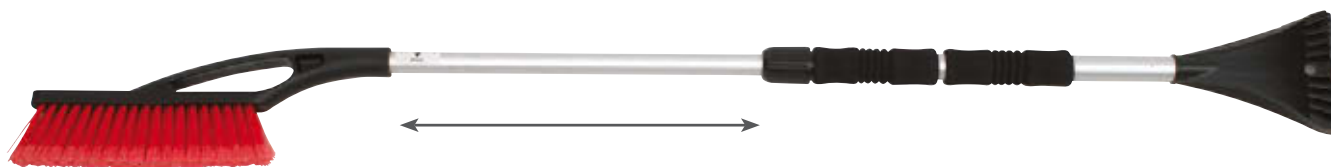

ARCTIC 58-0600660 Hand snow brush ARCTIC: with retractable telescope system, ice scraper on one side, hand brush on the other side, rubberized grips.

Packing: 20 pcs. | Size: 90x11 cm | Branding: ☒ 40x25 mm K2+H5



UNDER PRESSURE 58-0300670 Tire pressure measuring device UNDER PRESSURE: with LCD display, emergency hammer, integrated LED flashlight, 5 tools and a headlamp, made of plastic and stainless steel, delivered in box, battery: 1 x AAA (excl.).

Packing: 40 pcs. / 20 pcs. | Size: 16x7 x2,7 cm | Branding: ☒ 30x20 mm K2+H3+V2 | ☒ 30x20 mm L2+H3

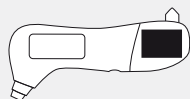



SOLID 58-0800207 Hanger SOLID: foldable to save space, made of aluminium, delivered in case with fitting protection cover.

Packing: 100 pcs. / 50 pcs. | Size: 13,2x5x1,1 cm | Branding: ☒ 30x15 mm L2+H3







We will spread your good reputation all over the world.

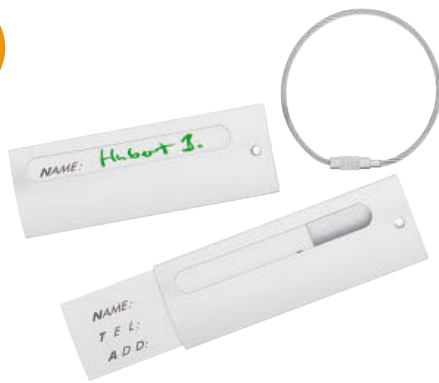

TAKE OFF 58-0401447 Luggage tag TAKE OFF: with address section, robust metal wire with secure lock, made of aluminium.
 Packing: 100 pcs. / 20 pcs. | Size: 9x3x0,9 cm | Branding:  50x10 mm K2+H3+V2 |  40x10 mm L1+H3



NOMINAL 58-0200017 Luggage tag NOMINAL: includes address card, robust metal wire with secure lock, made of aluminium.
 Packing: 500 pcs. / 100 pcs. | Size: 8,5x3x0,9 cm |
 Branding:  35x8 mm K1+H3+V2 |  35x8 mm DP1+H2 |  35x8 mm L1+H3

TRAVELLER 58-0402050 Luggage tag TRAVELLER: with integrated address field, robust metal wire with secure lock, made of stainless steel.
 Packing: 400 pcs. / 100 pcs. | Size: 8x4,1 cm | Branding:  50x15 mm DP1+H2 |  50x15 mm L1+H6





CARL 58-0800307 Luggage scale CARL: with LED display in handle, shows weight of suitcase in 0,01 kg steps, with hold and tare function, maximum weight: 50 kg - accurate to approx. 30 g, strong nylon loop with robust plastic grip, delivered in case.

Packing: 100 pcs. / 20 pcs. | Size: 15x8x3,5cm | Branding: ☒ 20x10mm K2+H4



FELIX 58-0800310 Toilet bag FELIX: with zip and carrying handle, 2 zip pockets inside, removable metal hook to hang it, made of water-repellent material - high quality artificial leather and polyester.

Packing: 10 pcs. | Size: 29x16x13 cm | Branding: ☒ 30x10mm L2+H2





58-0800351 red
58-0800352 blue



BEAUTY Manicure set BEAUTY: with foldable mirror, 5 make-up tools and 4 manicure tools (scissors, nail clipper, nail file, tweezers), designed like a handbag, made of PU, comes in a stylish box.

Packing: 60 pcs. /30 pcs. | Size: 12 x 13 x 3 cm | Branding: ☞ 60x25 mm K2+H3



58-0800331 red/silver
58-0800332 blue/silver
58-0800333 green/silver



LOOK AT ME Pocket mirror LOOK AT ME: aluminium on the inside, leatherette on the outside, with magnetic clip, comes in stylish box.

Packing: 100 pcs. /50 pcs. | Size: 6 x 6 x 1 cm | Branding: ☞ 30 x 30 mm K2+H3 | ☞ 30 x 30 mm DP1+H2



When betting on our items, there is no need to bite your nails!



NYKÖPING 58-0800170 Manicure set NYKÖPING, 5 pcs: consists of nail scissors, nail clipper, nail file, nail pliers and tweezers, in croc-look leatherette case with logo plate for your advertisement.

Packing: 80 pcs. / 10 pcs. | Size: 7,8x12,1x2 cm | Branding: 🗑️ 25x8 mm L2+H4

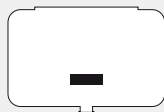

PICO CARE 58-0800328 Manicure set PICO CARE, 4 pcs: scissors, tweezers, nail clipper and nail file made of stainless steel, EVA foam on the inside - prevents shifting and rattling, in ultra-flat slipcase made of shiny aluminium.

Packing: 24 pcs. | Size: 10,7x8x1,5 cm | Branding: 🗑️ 60x15 mm K2+H4+V2 | 🗑️ 60x30 mm L2+H2

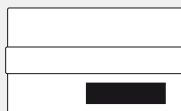

In attachments Small but great!

You know the sentence: „Good things come in small packages.“ Then you must also know, that it is the small things that makes people smile. A keyring doesn't just open doors, they also open the heart of customers and show appreciation. Give it a try!

Our picostyle key rings proves themselves as practical companions, which emphasise personality and style. Let our key rings convince you!

With integrated whistle



highlight



WHISTLE 58-0401890 Key ring WHISTLE: with extendable key ring and integrated whistle, made of matt polished stainless steel.

Packing: 200 pcs. / 50 pcs. | Size: 4,1 x 1,1 x 1,5 cm | Branding:  30 x 5 mm L1+H4





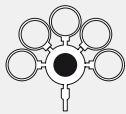

picostyle

DISQUE 58-0400077 Metal key ring DISQUE: with five removable rings.
 Packing: 250 pcs. /50 pcs. | Size: Ø2,5x10x1 cm | Branding:  Ø15 mm K2+H4+V2 |  8x8 mm L1+H4



PITO 58-0400207 Key ring PITO: with a whistle, made of metal and plastic, high gloss chrome-plated key ring.
 Packing: 250 pcs. /50 pcs. | Size: 8x3,5x1 cm | Branding:  25x15 mm K2+H2+V2 |  30x15 mm L1+H2



NOTEBOOK 58-0401697 Metal key holder NOTEBOOK, foldable: with 3 key rings and integrated picture frame, with magnetic closure.
 Packing: 200 pcs. /50 pcs. | Size: 4x4,5x0,6 cm | Branding:  25x15 mm K2+H2+V1 |  30x15 mm L1+H2

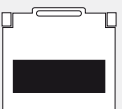

Advertising on key chains pays off!



COINLESS 58-0400167 Key ring COINLESS: with integrated EURO-sized chip, made of stainless steel.

Packing: 300 pcs. / 50 pcs. | Size: 9,5x3,2x0,5 cm |

Branding: ☒ 20x10 mm K2+H4+V2 | ☒ 16x4 mm L1+H4



CARRY 58-0401717 Metal key holder CARRY: shopping bag design, with integrated EURO-sized chip, key ring with carabiner.

Packing: 250 pcs. / 50 pcs. | Size: 10,5x3,2x0,9 cm |

Branding: ☒ 25x20 mm K2+H2+V2 | ☒ 25x23 mm L1+H2



CHAMBA 58-0401787 Metal key chain CHAMBA: designed in the shape of a pig, with integrated EURO-sized chip, space for your advertisement on pendant and chip.

Packing: 250 pcs. / 50 pcs. | Size: 11 x 3,5 x 0,6 cm |

Branding: ☒ 25 x 10 mm K2+H4+V2 | ☒ 20 x 10 mm L1+H4



1



2



3



4



5



6







*In exclusive
PiCOWORLD-design*



*In exclusive
PiCOWORLD-design*

1 PESCADO 58-0401767 Key chain PESCADO: designed in the shape of a fish, steel wire with PiCOWORLD quick fastener, shiny chrome finish.

Packing: 300 pcs. / 50 pcs. | Size: 4,1x2x0,7 cm |

Branding:  20x10 mm K2+H4+V2 |  10x6 mm L1+H4



2 PAJARO 58-0401777 Key ring PAJARO: designed in the shape of a bird, steel wire with PiCOWORLD quick fastener, shiny chrome finish.

Packing: 300 pcs. / 50 pcs. | Size: 4,1x2x0,7 cm | Branding:  10x6 mm K2+H4+V2 |

 10x6 mm L1+H4



3 GATO 58-0400117 Key ring GATO: designed in the shape of a cat, steel cable with secure snap-in mechanism, made of high gloss chrome-plated metal.

Packing: 300 pcs. / 50 pcs. | Size: 4,3x2x0,7 cm | Branding:  10x6 mm K2+H4+V2 |

 10x6 mm L1+H4



4 PERRO 58-0400107 Key ring PERRO: designed in the shape of a dog, steel cable with snap-in mechanism, made of high gloss chrome-plated metal.



Packing: 300 pcs. / 50 pcs. | Size: 4x2,2x0,7 cm | Branding:  10x6 mm K2+H4+V2 |

 10x6 mm L1+H2



5 FLY AWAY 58-0401177 Key ring FLY AWAY: with 3 removable rings, plane has to be turned to open the ring, rubberized bottom side, made of high gloss chrome-plated metal.

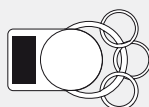

Packing: 250 pcs. / 50 pcs. | Size: 5,5x3,4x1,4 cm |

Branding:  20x5 mm K2+H2+V2 |  15x10 mm L1+H2



6 SPEED 58-0401237 Key ring SPEED: designed in the shape of an automatic gearshift, use lever to open lock, made of metal.

Packing: 200 pcs. / 50 pcs. | Size: 5,4x3,1x1,4 cm |

Branding:  25x8 mm K2+H2+V2 |  25x12 mm L1+H2



Keep your keys on a leash!



DOGGY 58-0402065 Key finder DOGGY: barks and flashes lights - activated by clapping your hands – with rubberized leash to attach to keys, batteries: 3 x AG13/LR44 (incl.).

Packing: 200 pcs. / 20 pcs. | Size: 6x5x2,3 cm | Branding: ☒ 15x5 mm K1+H3

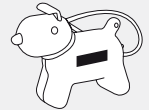

HIGHWAY 58-0400197 Key ring HIGHWAY: designed in the shape of a race car, with two bright LED lights, made of metal.

Packing: 200 pcs. / 50 pcs. | Size: 9x3,3x0,9 cm | Branding: ☒ 31x9 mm L1+H2





FORTUNA 58-0401737 Key holder FORTUNA: separable chrome-plated metal dice, with space on dice for your advertisement.

Packing: 200 pcs. / 50 pcs. | Size: 8,6x2 cm | Branding: 🗑️ 10x10 mm L1+H2



CARDS 58-0400187 Key ring CARDS: untwist ring to attach key, made of chrome-plated metal.

Packing: 250 pcs. / 50 pcs. | Size: 7,7x5,1x0,4 cm | Branding: 🗑️ 30x15 mm L1+H2



HEART 58-0401450 Metal key ring HEART: designed in the shape of a heart, with practical snap lock and 3 removable rings.

Packing: 250 pcs. / 50 pcs. | Size: 4,1x4,1x0,6 cm |

Branding: 🗑️ 20x10 mm K2+H2+V2 | 🗑️ 20x10 mm L1+H2



The best gifts
come from
the heart.



LOVELY 58-0401900 Key ring LOVELY: designed in the shape of a heart, made of highly polished stainless steel.

Packing: 200 pcs. / 50 pcs. | Size: 3,9x4x0,3 cm | Branding: 🗑️ 20x10 mm L1+H2





Hold the key to advertisement!





BELTO 58-0401260 Key ring BELTO: designed in the shape of a belt buckle, with black hanger made of solid polyurethane, secure metal lock.

Packing: 200 pcs. / 50 pcs. | Size: 8,5x2x0,7 cm |

Branding:  25x12 mm K2+H2+V2 |  25x12 mm L1+H2





ESTRELLA 58-0401810 Key chain ESTRELLA: designed in the shape of a star, leatherette with contrasting white stitches and engraving plate, metal key ring.

Packing: 250 pcs. / 50 pcs. | Size: 10x5x0,5 cm | Branding:  Ø 12 mm K2+H2+V2 |  10x10 mm L1+H2



LABEL 58-0401700 Key holder LABEL: in real leatherette with contrasting white stitches and engraving plates with zinc alloy, key ring is made of metal.

Packing: 250 pcs. / 50 pcs. | Size: 10,7x3,3x0,7 cm |

Branding:  25x10 mm K2+H2+V2 |  30x10 mm L1+H2



Refined with a CRYSTALLIZED™-
Swarovski Element



KAI TAK 58-0401430 Key ring KAI TAK: with 2 key rings, high quality leatherette and one CRYSTALLIZED™-Swarovski Element – pendant can be extended.

Packing: 250 pcs. / 50 pcs. | Size: 6,2x3,2x1,9 cm | Branding: 📏 13x10 mm L1+H2



WITH LOVE 58-8041102 Key finder WITH LOVE: with shiny red heart clip and key ring to attach the key, made of zinc alloy and stainless steel.

Packing: 250 pcs. / 50 pcs. | Size: 11x2,8x2,2 cm |

Branding: 📏 Ø 15 mm K2+H4+V1 | 📏 20x10 mm L1+H4



without decoration



LENI 58-0401837 Key finder LENI: with carabiner to attach key and nice engraving plate, made of zinc cast and stainless steel, delivered in gift box.

Packing: 250 pcs. / 50 pcs. | Size: 12,5x3,5x1,5 cm |

Branding: 📏 Ø 20 mm K2+H3+V2 | 📏 20x20 mm L1+H3



Tastefully Excellent taste on show!



As you know, there is no accounting for taste. We are inspired by looking at the wine opener, cheese board and pepper mill. The stylish household products in noble design simply bring good taste into your kitchen. A feast for the eyes.

Enjoy the selection and let yourself be seduced by our appetizing picohome ideas. On the following pages you and your customers will find the right thing for every taste.



highlight

KITCHEN-EGG 58-0300487 Timer KITCHEN-EGG: 60-minute-scale, stylish shape of an egg, with black numbers on brushed metal.

Packing: 100 pcs./25 pcs. | Size: Ø6x7,5 cm | Branding:  20x12 mm K2+H3+V2 |  20x8 mm L2+H3







With alternating colours to visualize remaining time



These reliable timekeepers make your business tick.

DORI 58-0300597 Kitchen timer DORI, made of stainless steel: with LED indicator that changes colour to show the remaining time, green > 10 min, yellow 10 - 5 min, red < 5 min, on/off switch for the light, batteries: 2 x AA (excl.).

Packing: 40 pcs./20 pcs. | Size: Ø8x5 cm | Branding: ☞ Ø40 mm K2+H3 | ☞ Ø40 mm L2+H3



without decoration

 NEW

UFO 58-0300397 Kitchentimer UFO: 60-minute-scale, made of brush-finished metal.

Packing: 100 pcs./50 pcs. | Size: Ø7 x 4 cm | Branding: ☞ 25 x 15 mm K2+H2+V2 | ☞ 25 x 15 mm L2+H2

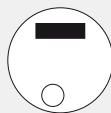

TOUCH'N'COOK 58-8036002 Kitchen timer

TOUCH'N'COOK: displays up to 99 min/59 sec, tone after set time expires, simple operation of touch buttons on display, with magnet and put-up hinge on the back side.

Packing: 120 pcs./60 pcs. | Size: 7,6x7,6x2,5 cm | Branding: ☞ 25x3 mm K1+H2



Hot! With this artful design, tea and coffee drinkers show good taste.

ENJOY 58-0300647 Hot chocolate and cappuccino shaker set ENJOY: includes shaker, heart and star stencils, made of stainless steel.

Packing: 48 pcs. | Size: 9xØ4 cm (dispenser)/Ø6,5cm (pattern) |
Branding: ☰ 60x15 mm K2+H3+V2 | ☞ 120x70 mm LR3+H3 360° |
☞ 60x15 mm L2+H4



TEA + HEART 58-0300655 Tea set TEA + HEART: stainless steel tea ball and heart-shaped ceramic bowl.

Packing: 48 pcs. | Size: 5,5x4x1,5cm (Tea infuser)/8x7,5x3cm (Bowl) |
Branding: ☰ 25x20 mm K2+H3+V2

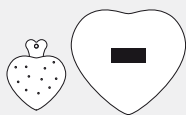

SALT N' PEPPER

58-0300615 Salt and pepper mill

SALT N' PEPPER: with robust ceramic mill and window, operated by pushing a button, delivered in case, batteries: 6 x AA (excl.).

Packing: 20 pcs. | Size: 21,6xØ6,8 cm | Branding:  30x20 mm K2+H4+V1



without decoration

High-quality, robust ceramic grinder

KOPENHAGEN

58-0300510 Salt and pepper mill

KOPENHAGEN: with window and ceramic grinder - 5 grinder levels selectable, incl. elegant storage tray with metal plate, made of plastic and brushed stainless steel.

Packing: 24 pcs. | Size: 22,3x6,3x5,5 cm | Branding:  30x10 mm L2+H3

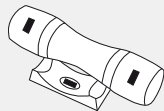



without decoration

5 grinding levels adjustable

OSLO

58-0300537 Salt and pepper set OSLO: made of polished metal.

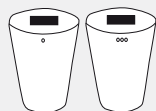

Packing: 50 pcs. / 10 pcs. | Size: 4,5x4,5x6 cm |

Branding:  90x35 mm LR3+H2 360° |  Ø24 mm L1+H2





The eye must be pleased.

BAMBOO-ROUND 58-0300469 Chopping board
BAMBOO-ROUND: with handy waste drain along the side, made from sturdy bamboo.

Packing: 10 pcs. | Size: 30 x 20 x 2 cm | Branding:  40 x 10 mm K2+H4+V1 |  200 x 200 mm DP2+H2 |  40 x 10 mm L2+H4



BAMBOO-GRIP 58-0300449 Chopping board BAMBOO-GRIP:
with handy metal handle, made from sturdy bamboo.



Packing: 10 pcs. | Size: 43 x 26 x 2 cm | Branding:  40 x 30 mm K2+H4+V1 |  200 x 200 mm DP2+H2 |  40 x 30 mm L2+H4



*With twist mechanism
to open and close*



KAAS 58-0300609 Cheese set KAAS: 2 cheese knives and a fork, made of stainless steel with wooden grips, in bamboo box with slideable lid that can be used as a chopping board, delivered in a black box.

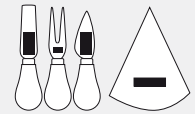

Packing: 24 pcs. | Size: 22,5x20x3 cm | Branding:  60x20 mm K2+H4 |  70x20 mm K2+H4+V2 |  70x20 mm L2+H4



*With protection covers
for the blades*



CERA-TRIO 58-8031000 Ceramic knife set CERA-TRIO, 3 pcs: comprises bread knife, all-round knife and peeler, with rust-proof ceramic blades and plastic grips, delivered in gift box.

Packing: 10 pcs. | Size: 30,5x22x2,8cm | Branding:  70x30 mm DP2+H2 |  35x10 mm L2+H4

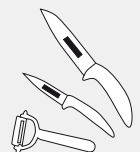



A high-class dinner calls for only the best ingredients!



*High-quality, rust-free
and robust ceramic blade*



CARBO-CUT 58-0300660 Ceramic knife CARBO-CUT: rust-proof ceramic blade and plastic handle with carbon finish, comes in stylish case.
Packing: 30 pcs. | Size: 24 x 3 x 2 cm | Branding:  30 x 10 mm K2+H3+V2 |  80 x 30 mm DP2+H2 |  30 x 10 mm L2+H3



THANKSGIVING 58-0300587 Knife set THANKSGIVING, 3 pcs: knife, poultry shears and fork made from high quality stainless steel, in aluminium suitcase with latch and engraving plate.
Packing: 16 pcs. | Size: 33,6 x 14 x 3,5 cm | Branding:  50 x 30 mm L2+H2





With touch buttons



58-0300500 black
58-0300501 red
58-0300505 white





Design award 2009!

without decoration



TIME Digital kitchen scale TIME: with glass surface and touch panels, displays weight in kg, g, oz and lbs (can be set on the backside), analogue clock, weighs max. 3 kg, wall holder, made of plastic and glass, batteries: 3 x AAA (excl.), 1 x LR44 (incl.).



Packing: 6 pcs. | Size: Ø 20 x 2 cm | Branding:  40 x 20 mm K2+H3+V2 |  40 x 20 mm DP1+H2



Platform made of 300° heat resistant, scratch-proof safety glass



i-CONTROL 58-8036000 Digital kitchen scale i-CONTROL: illuminated LCD display, weight displayed in kg, g, oz and lbs, accurate to 1 g, weighs max. 3 kg, with hold and tare functions, glass surface heat resistant up to 300°, batteries: 3 x AAA (excl.).

Packing: 20 pcs. / 10 pcs. | Size: 23 x 16,2 cm | Branding:  40 x 30 mm K2+H6+V2 |  60 x 50 mm DP2+H2



COOKING-SCALE 58-0300310 Digital kitchen scale COOKING-SCALE: displays weight in kg, g, oz and lbs, accurate to 1 g, weighs max. 3 kg, made of glass and plastic, batteries: 2 x AAA (excl.).

Packing: 10 pcs. | Size: 21 x 17 x 3,3 cm | Branding:  30 x 10 mm K2+H4+V2

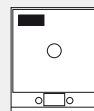

without decoration

58-0300470 silver/black
58-0300477 silver



No nut is too
tough to crack!

CRACK-IT Nutcracker CRACK-IT: incl. collecting pan with integrated fixture for the nutcracker, made of metal and plastic.

Packing: 20 pcs. | Size: Ø16x20,5 cm | Branding: ☞ 40x10 mm K2+H3+V1 |
☞ 28x9 mm L2+H3



CRÈME BRÛLÉE 58-8043001 Flambé burner CRÈME BRÛLÉE – ideal to caramelize desserts: with instruction manual, filled with gas and easy to refill.



Packing: 100 pcs. | Size: Ø2,5x19 cm | Branding: ☞ 40x10 mm K2+H4+V1 |
☞ 40x10 mm L2+H4





Good wines deserve to be presented well. Let's drink to that!

HELIX 58-0300557 Designer wine holder HELIX: robust quality, made of highly polished stainless steel.

Packing: 45 pcs. | Size: 15x15x8 cm | Branding:  40x30 mm K2+H4+V2 |  45x30 mm L2+H4





STEADY 58-0300907 Bottle holder STEADY: with convenient handle for unerring pouring, velvet velour inside, outside made of highly polished stainless steel.

Packing: 24 pcs. | Size: 23,5x7,5 cm | Branding:  50x10 mm L2+H4



COOL-IT 58-0300420 Designer bottle cooler COOL-IT: for wine and champagne bottles, with lid, made of solid plastic and brushed metal.

Packing: 18 pcs. | Size: 25,5x12,5x12 cm | Branding:  30x20 mm K2+H3+V2 |  30x20 mm L2+H3

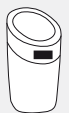

There are many occasions in life to celebrate and raise the glass in success.

PLEASURE 58-0300690 Wine set PLEASURE: wine thermometer, two drip rings, corkscrew, metal spout, bottle cap – made of stainless steel, includes elegant wooden stand, delivered in black box.

Packing: 24 pcs. | Size: 19,5x6x6 cm | Branding: ☞ 40x20 mm K2+H4



DAISY 58-0300380 Corkscrew DAISY: easy handling thanks to lever mechanism, chrome-plated with non-slip rubber parts.

Packing: 48 pcs. /6 pcs. | Size: 17,5x7,5x5 cm | Branding: ☞ 20x10 mm L2+H2



SERVICE 58-0300900 Waiter's knife SERVICE: with corkscrew, bottle opener and seal cutter, easy opening thanks to 2-stage lever mechanism, delivery in black box.

Packing: 100 pcs. | Size: 14x3x1,2 cm | Branding: ☞ 30x5 mm K2+H4



dries and warms the footwear up to the toes



DRY FEET 58-8036001 Shoe dryer DRYFEET: with automatic temperature control, 230 Volt socket connection, cable (length approx. 140cm).
Packing: 20 pcs. | Size: 14,2x5,4x3,1 cm | Branding: ☹ 30x7 mm K2+H5+V1

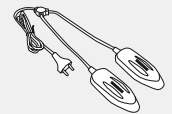

CLASSIC 58-0800120 Shoe cleaning set CLASSIC: includes 1 colourless polish, 2 different wooden shoe brushes, 1 shoehorn, 1 polishing cloth and 1 sponge to apply shoe polish, in leatherette case with button and white stitching.
Packing: 20 pcs. / 10 pcs. | Size: 16x6 cm | Branding: ☹ 70x10 mm T1+H3



Never lose sight of
your glasses again.



HANG-UP 58-8090001 Jewellery holder HANG-UP, figure made of polyresin with iron frame for hanging necklaces, rings and earrings, weight: approx. 79 g.

Packing: 36 pcs. | Size: Ø4,5x15 cm | Branding: ☒ 35x15 mm K2+H4+V1 | ☒ 35x15 mm L4+H4



SAFE 58-8090000 Eyeglasses holder SAFE, made of polyresin in form of a nose, weight: approx. 185 g – ideal for safe storage of glasses.

Packing: 36 pcs. | Size: 5,1 x 5,7 x 12,1 cm | Branding: ☒ 12x6 mm K2+H4+V1 | ☒ 12x6 mm L4+H4



All fun and games Jump for joy and play!

There are countless computer games. Just take a guess: what games are the most popular? Hard to believe but true – board games and parlour games! All this, even though the end of good old board games has already been presumed in the age of Internet. Long last the play passion!

Whichever game type you are, we have the right PiCOWORLD game for all! And the best of all? All our picogames can easily be taken along on trips, providing you and your customers with fun and relaxation on the way.



With rollable green (189 x 23 cm)

highlight

HOLE-IN-ONE 58-0500170 Golf set HOLE-IN-ONE: 3 pcs metal club with rubberized grip can be screwed together, rollable green (189x23 cm) with training hole, real golf ball, in leatherette golf bag - weighs less than 1 kg.

Packing: 10 pcs. | Size: 17 x 10 x 39 cm |
Branding:  50 x 10 mm K1+H3





picogame

You and your customers will play in the upper league!



TETRADE 58-0500067 Arcade game TETRADE: arrangeable aluminium playing area and colourful gaming pieces made of plastic, in handy aluminium box.

Packing: 50 pcs. / 10 pcs. | Size: 17 x 10,5 x 2 cm |
 Branding: ☒ 70x20 mm K2+H4+V1 | ☒ 160x100 mm DP2+H2 |
 ☒ 100x15 mm L2+H4



Game mat with 6 sensor areas

8 IN 1 GAME 58-0500265 Video game console 8 IN 1 GAME: 8 games (hurdle race, marathon, skiing, soccer, aerobics, skipping rope, hammer throwing and playing marbles), play rug with 6 sensor areas, BMI index display before game starts, displays burnt calories, excl. 4 x AA batteries.

Packing: 10 pcs. | Size: 10 x 15 x 3,3 cm / 68 x 38 cm | Branding: ☒ 70x15 mm K2+H4





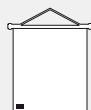

501 58-0500140 Dart game 501: stable unrollable cardboard, front and back side can be used to play, with 6 magnetic darts, can be hung up on plastic pole.
Packing: 12 pcs. | Size: 47,3x41 cm | Branding:  80x60 mm T1+H3



BEND 58-8051000 Dice game BEND: consists of 6 wooden pieces, made of different coloured bamboo, delivered in box, incl. answer sheet.
Packing: 80 pcs. /20 pcs. | Size: 7,5x7,5x7,5 cm | Branding:  20x10 mm K2+H4



UP + DOWN 58-8053000 Yo-yo UP + DOWN: with smooth metal movement, shows a star from the side, instruction manual for various games.
Packing: 150 pcs. /50 pcs. | Size: Ø5,6x3,5 cm | Branding:  20x10 mm DP1+H2 |  20x10 mm L2+H4

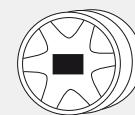



Your special service advantages!

Your special service advantages! "Excellent quality, reliable, on-time delivery. All at outstanding conditions!" That is our philosophy. And how can we live up to these ideals? With first-class service, of course!

- You can always count on our quick, reliable and on-time delivery!
- Before we add a product to our portfolio, we inspect it minutely in terms of its quality and function!
- Based on our experience and the right contacts, we can even make challenging custom-made products available to you at any time!
- You can order a sample of any product in advance – guaranteeing you a risk-free purchase!
- You can individualize every product with your name or logo – making the products even more unique!
- High-quality ideas deserve high-quality packaging: That is why we deliver many products in a stylish gift box!

Print code legend

The print codes at the end of the product descriptions give you details regarding the printing process and the cost of printing names or logos.

- K1 Advertising imprint: pad printing on plastic
- K2 Advertising imprint: pad printing on metal
- S1 Advertising imprint: screen printing on bags
- S2 Advertising imprint: screen printing on umbrellas
- T1 Advertising imprint: transfer printing < 8 x 8 cm
- T2 Advertising imprint: transfer printing > 8 x 8 cm
- L1 Advertising imprint: laser engraving standard article ¹
- L2 Advertising imprint: laser engraving on metal

¹ Maximum lettering size: 7 sq. cm, larger engravings upon request



58-0400600
UM3, AA, 1,5V
60/600 piece



58-0400610
UM4, AAA, 1,5V
60/1200 piece

Information legend



Gift packed

This product is supplied in one of PiCOWORLD's stylish gift boxes.



Bigsize refill

The delivery of the product is included with a bigsize refill.



Alarm

This product is equipped with alarm.



Snooze

This product is equipped with snooze facility.



Clock Radio

Radio controlled clock. No separate manual adjustment required.



Worldtime

This product shows you the different time zones in selected countries.



Countdown timer

Define a time period and the countdown timer counts it down to zero.



Calendar

This product is equipped with a monthly calendar.



Date display

This product is equipped with an additional date display.



Weather information

The exact weather information is shown via the measurement of the air pressure.



Thermometer

Amongst other things, this product indicates the outside and interior temperature.



Hygrometer

The integrated hygrometer indicates the current room climate and the air humidity.



Normal flame

This lighter is equipped with a normal flame.



Point of glow

This lighter is equipped with a flame of point of glow.



Jet flame

The jet flame, or also laser flame, reaches a temperature of up to 1.300 °C.



Earphone

A suitable earphone is included.



Magnetic

This product is magnetically sealed.



Including battery

The matching battery is included.



Including button cell battery

The correct coin cell battery is included in delivery.



USB Connection

This product is equipped with a USB port.



Solar operation

This product draws its power via solar cells and is therefore particularly environmentally friendly.



White Light LED

Especially bright luminosity plus long service life and low energy consumption.



Removable rings

You can remove the different rings of this key ring or fob or chain.



Genuine leather

This product is manufactured from high-quality leather, breathable, water and air-permeable, light-resisting and sturdy.

